



PROFESSIONAL KITCHEN EQUIPMENT

www.pimak.com



Professional Kitchen Equipments

2020/21

Ürün Kataloğu / Fiyat Listesi
Product Catalogue / Price List

BOGAZICI

DAMPAK

MİR RADIANS

gastrolley

Firmamız, kataloğumuzda belirtilen ürünlerdeki ölçü, fiyat ve renk değişiklik hakkını saklı tutar.
Bu katalog içerisindeki resim ve görseller hiçbir şekilde çoğaltılamaz ve kopyalanamaz.



Şirket Profili

1992 yılında ufak adımlar ama büyük hedeflerle yola çıktığımızda elimizdeki en büyük gücün kendimize olan inancımız ve işimize duymuş olduğumuz saygıdan ibaret olduğunun bilincindeydik. Zaman zaman ülke ekonomisindeki sert rüzgarlar bizlere zor anlar yaşattıysa da hayallerimizi asla engellemedi. Her geçen zaman beklentilerimizi haklı çıkardı. Kurulduğumuz günden bu güne kadar eksiklerimizi düzeltmek adına eleştirilere çok fazla önem verip yolumuza devam ettik. Rekabetin her zaman kaliteyi getireceğinin bilincindeydik. Bugün endüstriyel mutfak sektöründe **PiMAK** markasıyla Türkiye genelinde bayi, satış noktaları ve servis ağlarımız bulunmakta olup, yurt dışında 5 kıtada 45 farklı ülkeye ihracat yapmanın da haklı gururunu yaşamaktayız.

%100 Türk sermayesi ile kurulmuş olan şirketimiz geçen bu zamanda yurt içinde ve yurt dışında rekabetçi bir konuma gelmiştir. 7000 metrekaresi kapalı olmak üzere 10000 metrekareden oluşan tesisimizde üretim kapasitemiz, yıllık 1300 tondan 1750 tona çıkartmayı hedefliyoruz. Kurulduğu günden bu güne kadar ürün çeşitliliğini artırarak 800 farklı ürün portföyüne ulaşan firmamız; geniş çalışan kadrosu ve artan üretim kapasitesi ile ülke sanayisine katkı sunmaya devam etmektedir.

Çalışanlarımıza duymuş olduğumuz güven ve işimize göstermiş olduğumuz saygı ile inovasyon ve rekabet odaklı büyümemize devam edeceğiz. Yerimizi ve konumumuzu biliyor; ülke ekonomisine fayda sağlayacak her türlü çalışmayı alkışlıyoruz.

Company Profile

When we started our journey in 1992 with little steps towards great objectives, we knew that the greatest power we had was our faith in ourselves and the respect we had for our job. Although the tempest in the national economy made us go through hard time. We went on our journey attaching great importance to criticism in order to eliminate our inabilities since the day we were established. We always knew that competition would enhance quality. Today, we as **PiMAK** brand have distributors, sales points, service networks all across Turkey in terms of industrial kitchen, and we are proud to be exporting to 45 different countries in the 5 continents.











Our company which was founded with 100% Turkish capital has reached a competitive position both in domestic and foreign market. We aim to increase our annual production capacity from 1300 to 1700 tons in our facility that consist of 10000 square meters. (5000 square meters of it is closed area) Our company which has reached 800 different product portfolios since the day it was established is continueing to contribute to the country's industry thanks to its broad range of employees and increasing production capacity

Thanks to trust we have for our employees and respect we show to our business, we will continue our innovation and competition based growth. We know our place and position, and we appreciate all kinds of works that provide benefit to national.



Inspires Professionals...

İçindekiler Contents

600 Serie	600/Snack Serisi • 600/Snack Series	7
700 Serie	700 Serisi • 700 Series	15
900 Serie	900 Serisi • 900 Series	25
	Fırınlr • Owens	35
	Döner Makineleri • Shawarma Machines	49
	Piliç Çevrime Makineleri • ChckenGrills	57
	Kafeterya Ekipmanları • Cafeteria Equipments	65
	Hazırlık Ekipmanları • Preoaration Equipments	78
	Soğutma Ekipmanları • Cooling Equipments	105
	Servis Arabaları • Service Trolleys	128
	Bulaşıkxhane-Çamaşırhane • Scullery-Laundry	141
	Servis Hatları • Servis Unit Lines	149
	Mutfak Ekipmanları • Kitchen Equipments	157





600-Snack Serisi

600-Snack Series

600-Snack Serisi

600-Snack Series

Elektrikli, Musluklu/Musluksuz Set Model Fritözler

Electric, with or without Faucet Set-Model Fryers

Temel Özellikler

- Monofaze veya trifaze besleme
- Termostat kontrollü ısıtma
- Limit termostat
- Paslanmaz çelik gövde
- Boru rezistans (Musluklu modellerde hareketlidir)
- Paslanmaz sepet
- Hijyenik ve emniyetli
- Uzun ömürlü
- Kolay temizlenebilir yağ haznesi

Basic Features

- Single or three phase supply voltage
- Thermostatic controlled heating
- Limit thermostat
- Stainless steel body
- Pipe Resistane (Moving in faucet models)
- Stainless baskets
- Hygienic and safe
- Long life usage
- Easy to clean oil container



M062 (Eko Model)



M062-1 (Eko Model)



M169



M169-1

Teknik Özellikler | Technical Features

Ürün Kodu Product Code	Enerji Tipi Energy Type	Gerilim (Volt/Hz) Voltage (Volt/Hz)	Güç (kW/) Power (kW/)	Kapasite (Lt.) Capacity (Lt.)	Ebat (cm) Dimensions (cm)	Ağırlık (Kg.) Weight (Kg.)	Fiyat Price
M062 (Eko Model)	⚡	220-400 / 50-60	3,5	8	40x60x30	12	250 €
M062-1 (Eko Model)	⚡	220-400 / 50-60	7	8+8	60x60x30	16	420 €
M169	⚡	220-400 / 50-60	8,25	8	40x60x30	23	710 €
M169-1	⚡	220-400 / 50-60	16,5	8+8	70x60x30	35	1210 €

Elektrikli & Gazlı Pleyt Izgaralar

Electrical & Gas Plate Grills

Gazlı

- LPG veya doğalgaz ile çalışma
- Emniyet ventilli gaz musluğu
- Özel paslanmaz brülör tipi ısıtıcı
- Paslanmaz çelik gövde
- Oluklu veya düz pleyt seçeneği
- Hijyenik ve emniyetli
- Uzun ömürlü

Temel Özellikler

- Monofaze veya trifaze besleme
- Termostat kontrollü ısıtma
- Boru tipi rezistans ısıtıcı
- Paslanmaz çelik gövde
- Oluklu veya düz pleyt seçeneği
- Hijyenik ve emniyetli
- Uzun ömürlü

Elektrikli

Gas

- Working with LPG or natural gas
- Gas valve with safety valve
- Special stainless burner type heater
- Stainless steel body
- Corrugated or flat plate option
- Hygienic and safe
- Long lasting

Basic Features

- Single-phase or three-phase supply
- Thermostat controlled heating
- Tubular resistance heater
- Stainless steel body
- Corrugated or flat plate option
- Hygienic and safe
- Long lasting

Electrical



IZ4/M171-40



M064-70

Teknik Özellikler | Technical Features

Ürün Kodu Product Code	Enerji Tipi Energy Type	Gaz (Mbar) Gas (Mbar)	Güç (kW/kcal) Power (kW/kcal)	Ebat (cm) Dimensions (cm)	Ağırlık (Kg.) Weight (Kg.)	Fiyat (Düz) Price (Smooth)	Fiyat(Y.Oluklu) Price(Half Ribbed)
IZ4/M171-40	🔥	21/25-30/50	3,25/2795	40x60x30	30	460€	510€
IZ5/M171-70	🔥	21/25-30/50	6,5/5590	70x60x30	45	720€	780€

Ürün Kodu Product Code	Enerji Tipi Energy Type	Gerilim (Volt/Hz) Voltage (Volt/Hz)	Güç (kW/) Power (kW/)	Ebat (cm) Dimensions (cm)	Ağırlık (Kg.) Weight (Kg.)	Fiyat (Düz) Price (Smooth)	Fiyat(Y.Oluklu) Price(Half Ribbed)
M064-40	⚡	230-400 / 50-60	2,5	40x60x30	30	430 €	480€
M064-60	⚡	230-400 / 50-60	4	60x60x30	45	520 €	570€
M064-70	⚡	230-400 / 50-60	5	70x60x30	54	700 €	760€

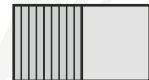
Düz
SmoothOluklu + Düz
Smooth + Ribbed

600-Snack Serisi

600-Snack Series

Gazlı Lavtaşlı Izgaralar

Gas Lava Stone Grilles

Temel Özellikler

- LPG veya doğalgaz ile çalışma
- Emniyet ventilli gaz musluğu
- Özel paslanmaz brülör tipi ısıtıcı
- Paslanmaz çelik gövde
- Özel döküm pleyt
- Hijyenik ve emniyetli
- Uzun ömürlü

Basic Features

- Working with LPG or natural gas
- Gas valve with safety valve
- Special stainless burner type heater
- Stainless steel body
- Special cast plate
- Hygienic and safe
- Long lasting



LT14/M170-1

Teknik Özellikler | Technical Features

Ürün Kodu Product Code	Enerji Tipi Energy Type	Gas (Mbar) Gas (Mbar)	Güç (kW/kcal) Power (kW/kcal)	Ebat (cm) Dimensions (cm)	Ağırlık (Kg.) Weight (Kg.)	Fiyat Price
LT14/M170-1	🔥	21/25-30/50	4/3440	47,5x60x30	47	560€
LT15/M170-2	🔥	21/25-30/50	8/6880	63x60x30	55	700€
LT16/M170-3	🔥	21/25-30/50	12/10320	78x60x30	72	960€

Gazlı & Elektrikli Ocaklar

Gas & Electric Cookers

Gazlı

- LPG veya doğalgaz ile çalışma
- Emniyet ventilli gaz musluğu
- Paslanmaz bek
- Paslanmaz çelik gövde
- Hijyenik ve emniyetli
- Uzun ömürlü

Temel Özellikler

- Monofaze veya trifaze besleme
- İki kademeli ısıtma
- 18 cm çaplı özel ısıtıcı pleyt
- Paslanmaz çelik gövde
- Hijyenik ve emniyetli
- Uzun ömürlü

Elektrikli**Gas**

- LPG or Natural Gas usage
- Faucet with safety valve
- Stainless burner
- Stainless steel body
- Hygienic and safe
- Long life usage

Basic Features

- Single or three phase supply voltage
- Two-stage heating
- Special hotplate with dia. 18 cm
- Stainless steel body
- Hygienic and safe
- Long life usage

Electrical**OC1/60MX-4S****60S-M068E****Teknik Özellikler | Technical Features**

Ürün Kodu Product Code	Enerji Tipi Energy Type	Gaz (Mbar) Gas (Mbar)	Güç (kW/kcal) Power (kW/kcal)	Kapasite (Ocak) Capacity (Cooker)	Ebat (cm) Dimensions (cm)	Ağırlık (Kg.) Weight (Kg.)	Fiyat Price
OC/60MX-2S	🔥	21/25-30/50	6,5/5590	2	40x60x30	18	370€
OC1/60MX-4S	🔥	21/25-30/50	13/11180	4	80x60x30	26	590€

Ürün Kodu Product Code	Enerji Tipi Energy Type	Gerilim (Volt/Hz) Voltage (Volt/Hz)	Güç (kW) Power (kW)	Kapasite (Ocak) Capacity (Cooker)	Ebat (cm) Dimensions (cm)	Ağırlık (Kg.) Weight (Kg.)	Fiyat Price
60S-M068E	⚡	230-400 / 50-60	4	Ø18 x 2	40x60x30	14	280€
60S-M068-1	⚡	230-400 / 50-60	8	Ø18 x 4	80x60x30	21	460€

600-Snack Serisi

600-Snack Series

Elektrikli Bain Marie & Elektrikli Makarna Haşlama

Electric Bain Marie & Electric Pasta Boiled

Temel Özellikler

- Monofaze besleme voltajı
- Termostat kontrollü ısıtma
- Boru tipi rezistans ısıtıcı
- Bain Marie'de standart GN kaplar
- Paslanmaz çelik gövde ve su haznesi
- Hijyenik ve emniyetli
- Uzun ömürlü

Basic Features

- Single-phase supply voltage
- Thermostat controlled heating
- Tubular resistance heater
- Standard GN containers in Bain Marie
- Stainless steel body and water tank
- Hygienic and safe
- Long lasting



M166



M066

Teknik Özellikler | Technical Features

Ürün Kodu Product Code	Enerji Tipi Energy Type	Gerilim (Volt/Hz) Voltage (Volt/Hz)	Güç (kW/) Power (kW/)	Kapasite Capacity	Ebat (cm) Dimensions (cm)	Ağırlık (Kg.) Weight (Kg.)	Fiyat Price
M166	⚡	230 / 50-60	2	1/3 GN 3 adet/pcs	40x60x30	14	320€
M167	⚡	230 / 50-60	2	1/3 GN 4 adet/pcs.	60x60x30	25	490€
M066	⚡	230-400 / 50-60	7,5	10 Lt.	40x60x30	17	630€

Neutral Bench & Potato Warm Display Unit

Nötr Tezgah Temel Özellikler

- Paslanmaz çelik gövde
- Boyut seçeneği
- Hijyenik ve emniyetli
- Uzun ömürlü

Patates Dinlendirme Temel Özellikler

- Stainless steel body and water container
- Various dimensions
- Hygienic and safe
- Long life usage

Neutral Countertop Basic Features

- Monofaze besleme voltajı
- Termostat kontrollü ısıtma
- Seramik ısıtıcı
- Paslanmaz çelik gövde ve hazne
- Hijyenik ve emniyetli
- Uzun ömürlü

Potato Warm Display Unit Basic Features

- Single phase supply voltage
- Thermostatic controlled heating
- Ceramic type heater Stainless Steel Paslanmaz Sac
- Stainless steel body and container
- Hygienic and safe
- Long life usage

**M067****M0168****Teknik Özellikler | Technical Features**

Ürün Kodu Product Code	Enerji Tipi Energy Type	Gerilim (Volt/Hz) Voltage (Volt/Hz)	Güç (kW/) Power (kW/)	Isıtma Tipi Heating Type	Ebat (cm) Dimensions (cm)	Ağırlık (Kg.) Weight (Kg.)	Fiyat Price
M067	-	-	-	-	40x60x30	11	160€
M067-1	-	-	-	-	60x60x30	16	210€
M0168	⚡	230 / 50-60	1	Kızılötesi - INFRARED	40x60x30	13	300€

600-Snack Serisi

600-Snack Series

Yer Ocakları

Stock Pot Ranges

Temel Özellikler

- Gazlı modellerde LPG veya Doğalgaz ile çalışma
- Gazlı modellerde emniyet ventilli gaz musluğu
- Gazlı modellerde çift yanış seçeneği
- Elektrikli modellerde monofaze veya trifaze besleme
- Elektrikli modellerde termostat kontrollü ısıtma
- Elektrikli modellerde ısıtıcı pleyt
- Paslanmaz çelik gövde
- Tam veya kısık yanış seçeneği
- Hijyenik ve emniyetli
- Uzun ömürlü

Basic Features

- Working with LPG or Natural Gas in gas models
- Gas valve with safety valve in gas models
- Double burn option in gas models
- Single-phase or three-phase supply in electric models
- Thermostat controlled heating in electric models
- Heating plate in electric models
- Stainless steel body
- Full or hoarse burning option
- Hygienic and safe
- Long lasting



M018

M018-1

M018E

Teknik Özellikler | Technical Features

Ürün Kodu Product Code	Enerji Tipi Energy Type	Gaz (Mbar) Gas (Mbar)	Güç (kW/kcal) Power (kW/kcal)	Kapasite (Ocak) Capacity (Cooker)	Ebat (cm) Dimensions (cm)	Ağırlık (Kg.) Weight (Kg.)	Gaz Tüketimi (m3/h-Kg/h) Gas Consumption (m3/h-Kg/h)	Fiyat Price
M018	🔥	21/25-30/50	3/2580	Tek Yanışlı / Single Flame	40x50x50	30	0,317-0,231	240€
M018-1	🔥	21/25-30/50	12,5/10750	Çift Yanışlı / Double Flame	60x70x50	48	1,323-0,986	380€
M018-2	🔥	21/25-30/50	25/21500	Üç Yanışlı / Triple Flame	70x80x50	65	2,21-1,57	630€

Ürün Kodu Product Code	Enerji Tipi Energy Type	Gerilim (Volt/Hz) Voltage (Volt/Hz)	Güç (kW/) Power (kW/)	Kapasite (Ocak) Capacity (Cooker)	Ebat (cm) Dimensions (cm)	Ağırlık (Kg.) Weight (Kg.)	Fiyat Price
M018E	⚡	230-400 / 50-60	4	30x30	40x50x50	18	450€
M018-1E	⚡	230-400 / 50-60	5	40x40	60x70x50	40	500€



700 Serisi
Serie 700



700 Serisi

Serie 700

700 Serisi

700 Series

700 Serisi
Serie 700

Gazlı & Elektrikli Ocaklar

Gas & Electric Cookers

Gazlı

- LPG veya doğalgaz ile çalışma
- Emniyet ventilli gaz musluğu
- Tam veya kısık yanış seçeneği
- Boru tip brülörlü termostat kontrollü fırın
- Paslanmaz brülör
- Paslanmaz çelik gövde
- Hijyenik ve emniyetli
- Uzun ömürlü

Temel Özellikler

- Trifaze besleme voltajı
- İki kademeli ısıtıcı pleytler
- Yuvarlak veya kare ısıtıcı pleyt seçeneği
- Termostat kontrollü fırın
- Paslanmaz çelik gövde
- Hijyenik ve emniyetli
- Uzun ömürlü

Elektrikli

Gas

- LPG or Natural Gas usage
- Faucet with safety valve
- Adjustable burner capacity
- Thermostatically controlled stove with tube type burner
- Stainless burner
- Stainless steel body
- Hygienic and safe
- Long life usage

Basic Features

- Three phase supply voltage
- Two-stage heating capacity
- Round or square hotplates
- Thermostatically controlled stove
- Stainless steel body
- Hygienic and safe
- Long life usage

Electrical



Teknik Özellikler | Technical Features

Ürün Kodu Product Code	Enerji Tipi Energy Type	Gaz (Mbar) Gas (Mbar)	Güç (kW/kcal) Power (kW/kcal)	Kapasite (Ocak) Capacity (Cooker)	Ebat (cm) Dimensions (cm)	Ağırlık (Kg.) Weight (Kg.)	Fiyat Price
OC2/70MX-2S	🔥	21/25-30/50	14/12040	2	40x70x30	22	520€
OC2/70MX-2D	🔥	21/25-30/50	14/12040	2	40x70x85	38	710€
OC3/70MX-4S	🔥	21/25-30/50	28/24080	4	80x70x30	45	800€
OC3/70MX-4D	🔥	21/25-30/50	28/24080	4	80x70x85	75	1100€
OC4/70MX-6S	🔥	21/25-30/50	42/36120	6	120x70x30	72	1100€
OC4/70MX-6D	🔥	21/25-30/50	42/36120	6	120x70x85	96	1300€
Ürün Kodu Product Code	Enerji Tipi Energy Type	Gerilim (Volt/Hz) Voltage (Volt/Hz)	Güç (kW/ Power (kW/)	Kapasite (Ocak) Capacity (Cooker)	Ebat (cm) Dimensions (cm)	Ağırlık (Kg.) Weight (Kg.)	Fiyat Price
70S-M182-2SE	⚡	230-400 / 50-60	4	Ø18 x 2	40x70x30	17	410€
70SDE-M182	⚡	230-400 / 50-60	4	Ø18 x 2	40x70x85	32	600€
70S-M182-4SE	⚡	230-400 / 50-60	8	Ø18 x 4	80x70x30	30	600€
70SDE-M182-1	⚡	230-400 / 50-60	8	Ø18 x 4	80x70x85	50	870€

Gazlı & Elektrikli Kuzineler

Gas & Electric Cookstoves

Gazlı

- LPG veya doğalgaz ile çalışma
- Emniyet ventilli gaz musluğu
- Tam veya kısık yanış seçeneği
- Boru tip brülörlü termostat kontrollü fırın
- Paslanmaz brülör
- Paslanmaz çelik gövde
- Hijyenik ve emniyetli
- Uzun ömürlü

Temel Özellikler

- Trifaze besleme voltajı
- İki kademeli ısıtıcı pleytler
- Yuvarlak veya kare ısıtıcı pleyt seçeneği
- Termostat kontrollü fırın
- Paslanmaz çelik gövde
- Hijyenik ve emniyetli
- Uzun ömürlü

Elektrikli

Gas

- LPG or Natural Gas usage
- Faucet with safety valve
- Adjustable burner capacity
- Thermostatically controlled stove with tube type burner
- Stainless burner
- Stainless steel body
- Hygienic and safe
- Long life usage

Basic Features

- Three phase supply voltage
- Two-stage heating capacity
- Round or square hotplates
- Thermostatically controlled stove
- Stainless steel body
- Hygienic and safe
- Long life usage

Electrical



70S-M015-4F



70SFE-M182-2

Teknik Özellikler | Technical Features

Ürün Kodu Product Code	Enerji Tipi Energy Type	Gaz (Mbar) Gas (Mbar)	Güç (kW/kcal) Power (kW/kcal)	Kapasite (Ocak+Fırın) Capacity (Cooker+Oven)	Ebat (cm) Dimensions (cm)	Ağırlık (Kg.) Weight (Kg.)	Fiyat Price
70S-M015-4F	🔥	21/25-30/50	39,2/33712	4+1	80x70x85	100	1480€
70S-M015-6F	🔥	21/25-30/50	58,8/50568	6+1	120x70x85	140	2100€
Ürün Kodu Product Code	Enerji Tipi Energy Type	Gerilim (Volt/Hz) Voltage (Volt/Hz)	Güç (kW) Power (kW)	Kapasite (Ocak+Fırın) Capacity (Cooker+Oven)	Ebat (cm) Dimensions (cm)	Ağırlık (Kg.) Weight (Kg.)	Fiyat Price
70SFE-M182-2	⚡	230-400 / 50-60	12	Ø18 x 4 + 1	80x70x85	100	1260€
70SFE-M182-3	⚡	230-400 / 50-60	29	Ø18 x 6 + 1	120x70x85	135	1680€

700 Serisi

700 Series

Gazlı Lavtaşlı & Sulu Tip Izgaralar

Gas Type Lavastone or Watery Grills

Temel Özellikler

- LPG veya doğalgaz ile çalışma
- Emniyet ventilli gaz musluğu
- Özel paslanmaz brülör tipi ısıtıcı
- Paslanmaz çelik gövde
- Özel döküm pleyt
- Hijyenik ve emniyetli
- Uzun ömürlü

Basic Features

- LPG or Natural Gas usage
- Faucet with safety valve
- Special stainless steel tube type burner
- Stainless steel body
- Special cast iron plate
- Hygienic and safe
- Long life usage



70S-M190-60
Sulu Tip | Watery



LTI/70S-M170-1



LTI/70SD-M170-1

Teknik Özellikler | Technical Features

Ürün Kodu Product Code	Model Tipi Model Type	Enerji Tipi Energy Type	Gaz (Mbar) Gas (Mbar)	Güç (kW/kcal) Power (kW/kcal)	Ebat (cm) Dimensions (cm)	Ağırlık (Kg.) Weight (Kg.)	Fiyat Price
70S-M190-60	Sulu Tip Watery	🔥	21/25-30/50	4 / 3440	61x70x35	46	900€
70S-M190-90	Sulu Tip Watery	🔥	21/25-30/50	6 / 5160	91x70x35	78	1100€
LTI/70S-M170-1	Lavtaşlı Lava Stone	🔥	21/25-30/50	4 / 3440	47,5x70x35	55	640€
LTI/70S-M170-2	Lavtaşlı Lava Stone	🔥	21/25-30/50	4 / 3440	63x70x35	70	770€
LTI1/70S-M170-3	Lavtaşlı Lava Stone	🔥	21/25-30/50	8 / 6880	78x70x35	102	1040€
LTI/70SD-M170-1	Lavtaşlı Lava Stone	🔥	21/25-30/50	4 / 3440	47,5x70x85	72	830€
LTI/70SD-M170-2	Lavtaşlı Lava Stone	🔥	21/25-30/50	4 / 3440	63x70x85	95	980€
LTI1/70SD-M170-3	Lavtaşlı Lava Stone	🔥	21/25-30/50	8 / 6880	78x70x85	127	1340€

Elektrikli & Gazlı Pleyt Izgaralar

Electric & Gas Plate Grilles

Gazlı

- LPG veya doğalgaz ile çalışma
- Ventilli gaz musluğu
- Paslanmaz boru tipi brülör
- Paslanmaz çelik gövde
- Oluklu veya düz pleyt seçeneği
- Hijyenik ve emniyetli
- Uzun ömürlü

Temel Özellikler

- Monofaze veya trifaze besleme
- Termostat kontrollü ısıtma
- Modellerde boru tipi rezistans ısıtıcı
- Paslanmaz çelik gövde
- Oluklu veya düz pleyt seçeneği
- Hijyenik ve emniyetli
- Uzun ömürlü

Elektrikli

Gas

- Working with LPG or natural
- Gas valve with safety valve
- Stainless pipe type burner
- Stainless steel body
- Corrugated or flat plate option
- Hygienic and safe
- Long lasting

Basic Features

- Single-phase or three-phase supply
- Thermostat controlled heating
- Tubular resistance heater
- Stainless steel body
- Corrugated or flat plate option
- Hygienic and safe
- Long lasting

Electrical



70SE-M179



IZ1/70SD-M171-2

Teknik Özellikler | Technical Features

Ürün Kodu Product Code	Enerji Tipi Energy Type	Gaz (Mbar) Gas (Mbar)	Güç (kW/kcal) Power (kW/kcal)	Ebat (cm) Dimensions (cm)	Ağırlık (Kg.) Weight (Kg.)	Fiyat (Düz) Price (Smooth)	Fiyat(Y.Oluklu) Price(Half Ribbed)
IZ/70S-M171	🔥	21/25-30/50	3,25/2795	40x70x30	35	640€	700€
IZ1/70S-M171-2	🔥	21/25-30/50	6,5/5590	80x70x30	64	790€	870€
IZ/70SD-M171	🔥	21/25-30/50	3,25/2795	40x70x85	50	830€	890€
IZ1/70SD-M171-2	🔥	21/25-30/50	6,5/5590	80x70x85	89	1060€	1140€
Ürün Kodu Product Code	Enerji Tipi Energy Type	Gerilim (Volt/Hz) Voltage (Volt/Hz)	Güç (kW/) Power (kW/)	Ebat (cm) Dimensions (cm)	Ağırlık (Kg.) Weight (Kg.)	Fiyat (Düz) Price (Smooth)	Fiyat(Y.Oluklu) Price(Half Ribbed)
70SE-M175	⚡	230-400 / 50-60	2,5	40x70x30	34	490€	550€
70SE-M179	⚡	230-400 / 50-60	6	80x70x30	65	800€	820€
70DE-M175	⚡	230-400 / 50-60	2,5	40x70x85	51	680€	740€
70DE-M179	⚡	230-400 / 50-60	6	80x70x85	90	1100€	1120€

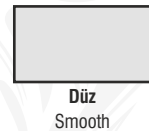

700 Serisi

700 Series

700 Serisi
Serie 700

Gazlı & Elektrikli Fritözler

Gas & Electric Fryers

Gazlı

- LPG veya doğalgaz ile çalışma
- Emniyet ventilli gaz musluğu
- Özel paslanmaz brülör
- Paslanmaz çelik gövde ve yağ haznesi
- Paslanmaz sepet
- Alt dolap seçeneği
- Yağ boşaltma musluğu
- Kolay temizlenebilir yağ haznesi
- Hijyenik ve emniyetli
- Uzun ömürlü

Temel Özellikler

- Monofaze veya trifaze besleme
- Termostat kontrollü ısıtma
- Limit termostat
- Hareketli paslanmaz boru tip rezistans
- Paslanmaz çelik gövde ve yağ haznesi
- Paslanmaz sepet
- Alt dolap seçeneği
- Yağ boşaltma musluğu
- Kolay temizlenebilir yağ haznesi
- Hijyenik ve emniyetli
- Uzun ömürlü

Elektrikli

Gas

- Working with LPG or natural gas
- Gas valve with safety valve
- Special stainless burner
- Stainless steel body and oil chamber
- Stainless basket
- Bottom cabinet option
- Oil drain cock
- Easy to clean oil chamber
- Hygienic and safe
- Long lasting

Basic Features

- Single-phase or three-phase supply
- Thermostat controlled heating
- Limit thermostat in electric models
- Movable stainless pipe type resistance
- Stainless steel body and oil chamber
- Stainless basket
- Bottom cabinet option
- Oil drain cock
- Easy to clean oil chamber
- Hygienic and safe
- Long lasting

Electrical



70SE-M073-1



70SDE-M073



70SDE-M073-1

Teknik Özellikler | Technical Features

Ürün Kodu Product Code	Enerji Tipi Energy Type	Gaz (Mbar) Gas (Mbar)	Güç (kW/kcal) Power (kW/kcal)	Kapasite (Lt.) Capacity (Lt.)	Ebat (cm) Dimensions (cm)	Ağırlık (Kg.) Weight (Kg.)	Fiyat Price
FR/70SD-M073	🔥	21/25-30/50	7 / 6020	12	40x70x85	38	1260€
FR1/70SD-M073-1	🔥	21/25-30/50	14 / 12040	12 + 12	80x70x85	65	2140€
Ürün Kodu Product Code	Enerji Tipi Energy Type	Gerilim (Volt/Hz) Voltage (Volt/Hz)	Güç (kW/) Power (kW/)	Kapasite (Lt.) Capacity (Lt.)	Ebat (cm) Dimensions (cm)	Ağırlık (Kg.) Weight (Kg.)	Fiyat Price
70SE-M073	⚡	230-400 / 50-60	9	12	40x70x30	20	720€
70SE-M073-1	⚡	230-400 / 50-60	18	12 + 12	80x70x30	35	1290€
70SDE-M073	⚡	230-400 / 50-60	9	12	40x70x85	37	930€
70SDE-M073-1	⚡	230-400 / 50-60	18	12 + 12	80x70x85	60	1610€

Elektrikli Makarna Haşlama

Electric Pasta Boiled

Temel Özellikler

- Monofaze besleme voltajı
- Termostat kontrollü ısıtma
- Boru tipi rezistans ısıtıcı
- Paslanmaz sepetler
- Paslanmaz çelik gövde ve su haznesi
- Hijyenik ve emniyetli
- Uzun ömürlü

Basic Features

- Single-phase supply voltage
- Thermostat controlled heating
- Tubular resistance heater
- Stainless baskets
- Stainless steel body and water tank
- Hygienic and safe
- Long lasting



70S-M184



70SD-M184

Teknik Özellikler | Technical Features

Ürün Kodu Product Code	Enerji Tipi Energy Type	Gerilim (Volt/Hz) Voltage (Volt/Hz)	Güç (kW/) Power (kW/)	Kapasite Capacity	Ebat (cm) Dimensions (cm)	Ağırlık (Kg.) Weight (Kg.)	Fiyat Price
70S-M184	⚡	230-400 / 50-60	7,5	10 Lt.	40x70x30	18	800€
70SD-M184	⚡	230-400 / 50-60	7,5	10 Lt.	40x70x85	34	990€

700 Serisi

700 Series

Elektrikli Bain Marie

Electric Bain Marie

Temel Özellikler

- Monofaze besleme voltajı
- Termostat kontrollü ısıtma
- Boru tipi rezistans ısıtıcı
- Bain Marie'de standart GN kaplar
- Paslanmaz çelik gövde ve su haznesi
- Hijyenik ve emniyetli
- Uzun ömürlü

Basic Features

- Single-phase supply voltage
- Thermostat controlled heating
- Tubular resistance heater
- Standard GN containers in Bain Marie
- Stainless steel body and water tank
- Hygienic and safe
- Long lasting



70S-M180-1



70SD-M180-1

Teknik Özellikler | Technical Features

Ürün Kodu Product Code	Enerji Tipi Energy Type	Gerilim (Volt/Hz) Voltage (Volt/Hz)	Güç (kW/) Power (kW/)	Kapasite Capacity	Ebat (cm) Dimensions (cm)	Ağırlık (Kg.) Weight (Kg.)	Fiyat Price
70S-M180-1	⚡	230 / 50-60	1,5	3 x 1/3 GN	40x70x30	20	380€
70SD-M180-1	⚡	230 / 50-60	1,5	3 x 1/3 GN	40x70x85	35	570€
70S-M180	⚡	230 / 50-60	2	2 x 1/1 GN	80x70x30	37	550€
70SD-M180	⚡	230 / 50-60	2	2 x 1/1 GN	80x70x85	60	820€

Nötr Tezgah & Patates Dinlendirme Ünitesi

Neutral Bench & Potato Warm Display Unit

Nötr Tezgah Temel Özellikler

- Paslanmaz çelik gövde
- Boyut seçeneği
- Hijyenik ve emniyetli
- Uzun ömürlü

Patates Dinlendirme Temel Özellikler

- Stainless steel body and water container
- Various dimensions
- Hygienic and safe
- Long life usage

Neutral Countertop Basic Features

- Monofaze besleme voltajı
- Termostat kontrollü ısıtma
- Seramik ısıtıcı
- Paslanmaz çelik gövde ve hazne
- Hijyenik ve emniyetli
- Uzun ömürlü

Potato Warm Display Unit Basic Features

- Single phase supply voltage
- Thermostatic controlled heating
- Ceramic type heater Stainless Steel Paslanmaz Sac
- Stainless steel body and container
- Hygienic and safe
- Long life usage



70S-M067



70S-M173



70SD-M173

Teknik Özellikler | Technical Features

Ürün Kodu Product Code	Enerji Tipi Energy Type	Gerilim (Volt/Hz) Voltage (Volt/Hz)	Güç (kW/) Power (kW/)	Isıtma Tipi Heating Type	Ebat (cm) Dimensions (cm)	Ağırlık (Kg.) Weight (Kg.)	Fiyat Price
70S-M067	-	-	-	-	40x70x30	14	180€
70SD-M067	-	-	-	-	40x70x85	31	370€
70S-M173	⚡	230 / 50-60	1	Kızılötesi - INFRARED	40x70x30	15	390€
70SD-M173	⚡	230 / 50-60	1	Kızılötesi - INFRARED	40x70x85	30	580€

900 Serisi
Serie 900





900 Serisi
Serie 900



900 Serisi

Serie 900

900 Serisi

9 00 Series

Gazlı & Elektrikli Ocaklar

Gas & Electric Cookers

Gazlı

- LPG veya doğalgaz ile çalışma
- Emniyet ventilli gaz musluğu
- Tam veya kısık yanış seçeneği
- Boru tip brülörlü termostat kontrollü fırın
- Paslanmaz brülör
- Paslanmaz çelik gövde
- Hijyenik ve emniyetli
- Uzun ömürlü

Temel Özellikler

- Trifaze besleme voltajı
- İki kademeli ısıtıcı pleytler
- Yuvarlak veya kare ısıtıcı pleyt seçeneği
- Termostat kontrollü fırın
- Paslanmaz çelik gövde
- Hijyenik ve emniyetli
- Uzun ömürlü

Elektrikli

Gas

- LPG or Natural Gas usage
- Faucet with safety valve
- Adjustable burner capacity
- Thermostatically controlled stove with tube type burner
- Stainless burner
- Stainless steel body
- Hygienic and safe
- Long life usage

Basic Features

- Three phase supply voltage
- Two-stage heating capacity
- Round or square hotplates
- Thermostatically controlled stove
- Stainless steel body
- Hygienic and safe
- Long life usage

Electrical



OC6/90SMX-4D



90SD-M068

Teknik Özellikler | Technical Features

Ürün Kodu Product Code	Enerji Tipi Energy Type	Gaz (Mbar) Gas (Mbar)	Güç (kW/kcal) Power (kW/kcal)	Kapasite Capacity	Ebat (cm) Dimensions (cm)	Ağırlık (Kg.) Weight (Kg.)	Fiyat Price
OC5/90SMX-2D	🔥	21/25-30/50	14/12040	2	40x90x85	65	810€
OC6/90SMX-4D	🔥	21/25-30/50	28/24080	4	80x90x85	108	1350€

Ürün Kodu Product Code	Enerji Tipi Energy Type	Gerilim (Volt/Hz) Voltage (Volt/Hz)	Güç (kW/) Power (kW/)	Pleyt Ebat Pleyt Size	Kapasite Capacity	Ebat (cm) Dimensions (cm)	Ağırlık (Kg.) Weight (Kg.)	Fiyat Price
90S-M067E	⚡	230-400 / 50-60	8	40 x 40cm	2	40x90x85	56	870€
90SD-M068	⚡	230-400 / 50-60	16	40 x 40cm	4	80x90x85	100	1400€

Gazlı & Elektrikli Kuzineler

Gas & Electric Cookstoves

Gazlı

- LPG veya doğalgaz ile çalışma
- Emniyet ventilli gaz musluğu
- Tam veya kısık yanış seçeneği
- Boru tip brülörlü termostat kontrollü fırın
- Paslanmaz brülör
- Paslanmaz çelik gövde
- Hijyenik ve emniyetli
- Uzun ömürlü

Temel Özellikler

- Trifaze besleme voltajı
- İki kademeli ısıtıcı pleytler
- Yuvarlak veya kare ısıtıcı pleyt seçeneği
- Termostat kontrollü fırın
- Paslanmaz çelik gövde
- Hijyenik ve emniyetli
- Uzun ömürlü

Elektrikli

Gas

- LPG or Natural Gas usage
- Faucet with safety valve
- Adjustable burner capacity
- Thermostatically controlled stove with tube type burner
- Stainless burner
- Stainless steel body
- Hygienic and safe
- Long life usage

Basic Features

- Three phase supply voltage
- Two-stage heating capacity
- Round or square hotplates
- Thermostatically controlled stove
- Stainless steel body
- Hygienic and safe
- Long life usage

Electrical



90S-M015-4F



90SF-M068

Teknik Özellikler | Technical Features

Ürün Kodu Product Code	Enerji Tipi Energy Type	Gaz (Mbar) Gas (Mbar)	Güç (kW/kcal) Power (kW/kcal)	Gaz Tüketimi(m3/h-Kg/h) Gas Consumption(m3/h-Kg/h)	Kapasite Capacity	Ebat (cm) Dimensions (cm)	Ağırlık (Kg.) Weight (Kg.)	Fiyat Price
90S-M015-4F	🔥	21/25-30/50	39,2/33712	4,148	4+1	80x90x85	147	1690€
90S-M015-6F	🔥	21/25-30/50	53,2/45752	5,630	6+1	120x90x85	170	2360€
M015-2	🔥	21/25-30/50	25,2/21672	2,666-1,987	2+1	100x65x85	75	1040€
M015-3	🔥	21/25-30/50	32,2/27692	3,406-2,541	3+1	150x65x85	113	1400€
M015-4	🔥	21/25-30/50	39,2/33712	4,147-3,092	4+1	100x100x85	160	1430€
M015-6	🔥	21/25-30/50	53,2/45752	5,628-4,196	6+1	150x100x85	200	1880€
KU-M015-2.6	🔥	21/25-30/50	58/49880	6,133-3,729	6+2	200x100x85	220	2800€

Ürün Kodu Product Code	Enerji Tipi Energy Type	Gerilim (Volt/Hz) Voltage (Volt/Hz)	Güç (kW/) Power (kW/)	Pleyt Ebat Pleyt Size	Kapasite Capacity	Ebat (cm) Dimensions (cm)	Ağırlık (Kg.) Weight (Kg.)	Fiyat Price
90SF-M068	⚡	230-400 / 50-60	24	40 x 40cm	4 + 1	80x90x85	135	1940€
MX26-4	⚡	230-400 / 50-60	21	40 x 40cm	4 + 1	100x100x85	150	1800€
MX26-6	⚡	230-400 / 50-60	29	40 x 40cm	6 + 1	150x100x85	195	2420€

900 Serisi

9 00 Series

Gazlı & Elektrikli Fritözler

Gas & Electric Fryers

Gazlı

- LPG veya doğalgaz ile çalışma
- Emniyet ventilli gaz musluğu
- Özel paslanmaz brülör
- Paslanmaz çelik gövde ve yağ haznesi
- Paslanmaz sepet
- Alt dolap seçeneği
- Yağ boşaltma musluğu
- Kolay temizlenebilir yağ haznesi
- Hijyenik ve emniyetli
- Uzun ömürlü

Temel Özellikler

- Monofaze veya trifaze besleme
- Termostat kontrollü ısıtma
- Limit termostat
- Hareketli paslanmaz boru tip rezistans
- Paslanmaz çelik gövde ve yağ haznesi
- Paslanmaz sepet
- Alt dolap seçeneği
- Yağ boşaltma musluğu
- Kolay temizlenebilir yağ haznesi
- Hijyenik ve emniyetli
- Uzun ömürlü

Elektrikli

Gas

- Working with LPG or natural gas
- Gas valve with safety valve
- Special stainless burner
- Stainless steel body and oil chamber
- Stainless basket
- Bottom cabinet option
- Oil drain cock
- Easy to clean oil chamber
- Hygienic and safe
- Long lasting

Basic Features

- Single-phase or three-phase supply
- Thermostat controlled heating
- Limit thermostat in electric models
- Movable stainless pipe type resistance
- Stainless steel body and oil chamber
- Stainless basket
- Bottom cabinet option
- Oil drain cock
- Easy to clean oil chamber
- Hygienic and safe
- Long lasting

Electrical



90S-M061E



90S-M062E

Teknik Özellikler | Technical Features

Ürün Kodu Product Code	Enerji Tipi Energy Type	Gaz (Mbar) Gas (Mbar)	Güç (kW/kcal) Power (kW/kcal)	Kapasite (Lt.) Capacity (Lt.)	Ebat (cm) Dimensions (cm)	Ağırlık (Kg.) Weight (Kg.)	Fiyat Price
90S-M061G	🔥	21/25-30/50	9 / 7740	24	40x90x85	60	1480€
90S-M062G	🔥	21/25-30/50	18 / 17200	24 + 24	80x90x85	92	2420€
Ürün Kodu Product Code	Enerji Tipi Energy Type	Gerilim (Volt/Hz) Voltage (Volt/Hz)	Güç (kW/) Power (kW/)	Kapasite (Lt.) Capacity (Lt.)	Ebat (cm) Dimensions (cm)	Ağırlık (Kg.) Weight (Kg.)	Fiyat Price
90S-M061E	⚡	230-400 / 50-60	10,5	24	40x90x85	48	1100€
90S-M062E	⚡	230-400 / 50-60	21	24 + 24	80x90x85	70	2010€

Elektrikli Izgaralar

Electric Grilles

Elektrikli

Temel Özellikler

- Monofaze veya trifaze besleme
- Termostat kontrollü ısıtma
- Boru tipi rezistans ısıtıcı
- Paslanmaz çelik gövde
- Oluklu veya düz pleyt seçeneği
- Hijyenik ve emniyetli
- Uzun ömürlü

Basic Features

- Single-phase or three-phase supply
- Thermostat controlled heating
- Tubular resistance heater
- Stainless steel body
- Corrugated or flat plate option
- Hygienic and safe
- Long lasting

Electrical

900 Serisi
Serie 900

90SD-M064E



90SD-M065E

Teknik Özellikler | Technical Features

Ürün Kodu Product Code	Enerji Tipi Energy Type	Gerilim (Volt/Hz) Voltage (Volt/Hz)	Güç (kW/) Power (kW/)	Ebat (cm) Dimensions (cm)	Ağırlık (Kg.) Weight (Kg.)	Fiyat (Düz) Price (Smooth)	Fiyat(Y.Oluklu) Price(Half Ribbed)
90SD-M064E	⚡	230-400 / 50-60	4,5	40x90x85	70	730€	810€
90SD-M065E	⚡	230-400 / 50-60	9	80x90x85	150	1400€	1500€

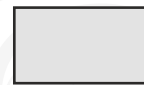
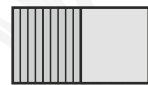
Düz
SmoothOluklu+Düz
Smooth+Ribbed

900 Serisi

9 00 Series

900 Serisi
Serie 900

Gazlı Izgaralar

Gas Grilles

Gazlı

Temel Özellikler

- LPG veya doğalgaz ile çalışma
- Emniyet ventilli gaz musluğu
- Paslanmaz boru tipi brülör
- Paslanmaz çelik gövde
- Özel döküm pleyt
- Diğer modellerde oluklu veya düz pleyt seçeneği
- Hijyenik ve emniyetli
- Uzun ömürlü

Basic Features

- Working with LPG or natural gas
- Gas tap with safety valve
- Stainless pipe type burner
- Stainless steel body
- Custom cast pleyt
- Choice of corrugated or flat pleyt on other models
- Hygienic and safe
- Long-lived

Gas



IZ3/90SD-M171



IZ3/90SD-M171-1

Teknik Özellikler | Technical Features

Ürün Kodu Product Code	Enerji Tipi Energy Type	Gaz (Mbar) Gas (Mbar)	Güç (kW/kcal) Power (kW/kcal)	Ebat (cm) Dimensions (cm)	Ağırlık (Kg.) Weight (Kg.)	Fiyat (Düz) Price (Smooth)	Fiyat(Y.Oluklu) Price(Half Ribbed)
IZ2/90SD-M171	🔥	21/25-30/50	3,25/2795	40x90x85	75	840€	920€
IZ3/90SD-M171-1	🔥	21/25-30/50	6,5/5590	80x90x85	145	1120€	1220€



Düz
Smooth

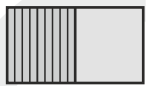

Oluklu + Düz
Smooth + Ribbed

Gazlı Lavtaşlı Izgaralar

Gas Type Lavastone Grills

Gazlı

Temel Özellikler

- LPG veya doğalgaz ile çalışma
- Emniyet ventilli gaz musluğu
- Paslanmaz boru tipi brülör
- Paslanmaz çelik gövde
- Özel döküm pleyt
- Diğer modellerde oluklu veya düz pleyt seçeneği
- Hijyenik ve emniyetli
- Uzun ömürlü

Basic Features

- Working with LPG or natural gas
- Gas tap with safety valve
- Stainless pipe type burner
- Stainless steel body
- Custom cast pleyt
- Choice of corrugated or flat pleyt on other models
- Hygienic and safe
- Long-lived

Gas

900 Serisi
Serie 900

LT3/90SD-M170-1



LT3/90SD-M170-3

Teknik Özellikler | Technical Features

Ürün Kodu Product Code	Enerji Tipi Energy Type	Gerilim (Volt/Hz) Voltage (Volt/Hz)	Güç (kW/) Power (kW/)	Ebat (cm) Dimensions (cm)	Ağırlık (Kg.) Weight (Kg.)	Fiyat Price
LT2/90SD-M170-1	🔥	21/25-30/50	4 / 3440	51,5x90x85	90	1100€
LT3/90SD-M170-3	🔥	21/25-30/50	8 / 6880	85x90x85	160	1380€

900 Serisi

9 00 Series

900 Serisi
Serie 900

Elektrikli Bain Marie

Electric Bain Marie

Temel Özellikler

- Monofaze besleme voltajı
- Termostat kontrollü ısıtma
- Boru tipi rezistans ısıtıcı
- Standart GN kaplar
- Paslanmaz çelik gövde ve sU haznesi
- Hijyenik ve emniyetli
- Uzun ömürlü

Basic Features

- Single-phase supply voltage
- Thermostat controlled heating
- Tubular resistance heater
- Standard GN containers
- Stainless steel body and water tank
- Hygienic and safe
- Long lasting



90SD-M069E

Teknik Özellikler | Technical Features

Ürün Kodu Product Code	Enerji Tipi Energy Type	Gerilim (Volt/Hz) Voltage (Volt/Hz)	Güç (kW/) Power (kW/)	Kapasite Capacity	Ebat (cm) Dimensions (cm)	Ağırlık (Kg.) Weight (Kg.)	Fiyat Price
90SD-M069E	⚡	230 / 50-60	1,5	3 x 1/3 GN	40x90x85	40	660€
90SD-M070E	⚡	230 / 50-60	2,5	2 x 1/1 GN	80x90x85	75	940€

Elektrikli Makarna Haşlama

Electric Pasta Boiled

Temel Özellikler

- Monofaze besleme voltajı
- Termostat kontrollü ısıtma
- Boru tipi rezistans ısıtıcı
- Paslanmaz sepetler
- Paslanmaz çelik gövde ve su haznesi
- Hijyenik ve emniyetli
- Uzun ömürlü

Basic Features

- Single-phase supply voltage
- Thermostat controlled heating
- Tubular resistance heater
- Stainless baskets
- Stainless steel body and water tank
- Hygienic and safe
- Long lasting



Teknik Özellikler | Technical Features

Ürün Kodu Product Code	Enerji Tipi Energy Type	Gerilim (Volt/Hz) Voltage (Volt/Hz)	Güç (kW/) Power (kW/)	Kapasite Capacity	Ebat (cm) Dimensions (cm)	Ağırlık (Kg.) Weight (Kg.)	Fiyat Price
90SD-M184E	⚡	230-400 / 50-60	10,5	1/2 + 2x1/6	40x90x85	45	1050€

Nötr Tezgah

Neutral Bench

**Nötr Tezgah Temel Özellikler**

- Paslanmaz çelik gövde
- Boyut seçeneği
- Hijyenik ve emniyetli
- Uzun ömürlü

Neutral Countertop Basic Features

- Stainless steel body and water container
- Various dimensions
- Hygienic and safe
- Long life usage

Teknik Özellikler | Technical Features

Ürün Kodu Product Code	Enerji Tipi Energy Type	Gerilim (Volt/Hz) Voltage (Volt/Hz)	Güç (kW/) Power (kW/)	Isıtma Tipi Heating Type	Ebat (cm) Dimensions (cm)	Ağırlık (Kg.) Weight (Kg.)	Fiyat Price
90SD-M067	-	-	-	-	40x90x85	31	390€

Patates Dinlendirme Ünitesi

Potato Warm Display Unit

**Patates Dinlendirme Temel Özellikler**

- Monofaze besleme voltajı
- Termostat kontrollü ısıtma
- Seramik ısıtıcı
- Paslanmaz çelik gövde ve hazne
- Hijyenik ve emniyetli
- Uzun ömürlü

Potato Warm Display Unit Basic Features

- Single phase supply voltage
- Thermostatic controlled heating
- Ceramic type heater Stainless Steel Paslanmaz Sac
- Stainless steel body and container
- Hygienic and safe
- Long life usage

Teknik Özellikler | Technical Features

Ürün Kodu Product Code	Enerji Tipi Energy Type	Gerilim (Volt/Hz) Voltage (Volt/Hz)	Güç (kW/) Power (kW/)	Isıtma Tipi Heating Type	Ebat (cm) Dimensions (cm)	Ağırlık (Kg.) Weight (Kg.)	Fiyat Price
90SD-M168E	⚡	230 / 50-60	1	Kızılötesi - INFRARED	40x90x85	35	750€

900 Serisi

9 00 Series

900 Serisi
Serie 900

Devrilir Tava

Tilting Bratt Pan

Devrilir Tava Temel Özellikler

- Gövde, panel, tava AISI 304 paslanmaz çelik.
- Termostatik kontrol
- Her çeşit hafif yağda kızartma, haşlanmış et, balık, yumurta, pilav, dolma ve sos yapma imkanı vardır
- Tava kalkarken kullanım emniyetini sağlamak için elektrikli modellerde ısıtıcı stop pozisyonuna geçer
- Musluk ile doldurma ve yıkama yapmaktır kolaydır
- Hijyenik, sağlıklı ve dayanıklıdır.

Tilting Bratt Pan Basic Features

- Body, panel and pan is AISI 304 stainless steel
- Thermostatic control
- Frying all the grilling kinds in light oil, (Frying, boiled meat, fish, egg, rice and sauce
- Heater passes to stop position when the pan works for providing safe usage
- It is easy to fill and discharge with the faucet
- Hygienic, ergonomic, safe usage.



90S-DTG-80

Ürün Kodu Product Code	Enerji Tipi Energy Type	Gaz (Mbar) Gas (Mbar)	Güç (kW/kcal) Power (kW/kcal)	Kapasite (Lt.) Capacity (Lt.)	Ebat (cm) Dimensions (cm)	Ağırlık (Kg.) Weight (Kg.)	Fiyat Price
90S-DTG-80	🔥	21/25-30/50	22	80	80x90x85	173	2780€
90S-DTG-120	🔥	21/25-30/50	28,5	120	120x90x85	230	3660€
Ürün Kodu Product Code	Enerji Tipi Energy Type	Gerilim (Volt/Hz) Voltage (Volt/Hz)	Güç (kW) Power (kW)	Kapasite (Lt.) Capacity (Lt.)	Ebat (cm) Dimensions (cm)	Ağırlık (Kg.) Weight (Kg.)	Fiyat Price
90S-DTE-80	⚡	380-400 / 50-60	10,2	80	80x90x85	163	2730€
90S-DTE-120	⚡	380-400 / 50-60	16	120	120x90x85	220	3750€

Kaynatma Kazanı

Boiling Pan

Kaynatma Kazanı Temel Özellikler

- AISI 304 paslanmaz çelik .
- Karşı ağırlıklı kapaklıdır
- Çift cidarlı ceketteki su seviyesi için doldurma ve kontrol musluğu seviyesi işareti vardır
- Aşırı basınç valfi ve monometre bulunur
- Soğuk sıcak su doldurma musluğu vardır
- Boşaltma muslukludur
- Brülör komple magnet ventillidir.

Boiling Pan Basic Features

- Made of AISI 304 (Cr-Ni 18/1 O) stainless steel
- With counterweighted cap
- There is a filling and check tap level mark for the water level in the double jacket
- Includes overpressure valve and monometer
- It has cold hot water filling tap
- With drain tap
- Burner has complete magnet valve.



Ürün Kodu Product Code	Enerji Tipi Energy Type	Gaz (Mbar) Gas (Mbar)	Güç (kW/kcal) Power (kW/kcal)	Kapasite (Lt.) Capacity (Lt.)	Ebat (cm) Dimensions (cm)	Ağırlık (Kg.) Weight (Kg.)	Fiyat Price
90S-KKG-80	🔥	21/25-30/50	22,5/19350	80	80x90x85	140	3500€
90S-KKG-100	🔥	21/25-30/50	28,5/24510	100	80x90x85	155	4000€
90S-KKG-150	🔥	21/25-30/50	33,5/28810	150	80x90x85	180	4300€
Ürün Kodu Product Code	Enerji Tipi Energy Type	Gerilim (Volt/Hz) Voltage (Volt/Hz)	Güç (kW) Power (kW)	Kapasite (Lt.) Capacity (Lt.)	Ebat (cm) Dimensions (cm)	Ağırlık (Kg.) Weight (Kg.)	Fiyat Price
90S-KKE-80	⚡	230-400 / 50-60	12	80	80x90x85	135	3500€
90S-KKE-100	⚡	230-400 / 50-60	12	100	80x90x85	150	3640€
90S-KKE-150	⚡	230-400 / 50-60	17	150	80x90x85	175	3780€



Firinalar
Ovens

PiMAK

Firinalar

Ovens

Patisserie Fırınlar

Patisserie Ovens

Temel Özellikler

- Elektrikli modellerde monofaze veya trifaze besleme
- Gazlı modellerde LPG veya Doğalgaz ile çalışma
- Termostat kontrollü ısıtma
- Fanlı hava sirkülasyonu
- Nemlendirme
- Paslanmaz çelik gövde
- Isıya dayanıklı çift cam
- Pişirme zamanlayıcı
- Hijyenik ve emniyetli
- Uzun ömürlü

Basic Features

- Single-phase or three-phase supply in electric models
- Working with LPG or Natural Gas in gas models
- Thermostat controlled heating
- Fan air circulation
- Moistening
- Stainless steel body
- Heat resistant double glass
- Cooking timer
- Hygienic and safe
- Long lasting



PTS04-DİJİTAL



PTS06-DİJİTAL



PTS09-MANUEL

Teknik Özellikler | Technical Features

Ürün Kodu Product Code	Enerji Tipi Energy Type	Gerilim (Volt/Hz) Voltage (Volt/Hz)	Güç (kW/) Power (kW/)	Kapasite (Tepsi-Adet) Capacity (Tray-Quantity)	Ebat (cm) Dimensions (cm)	Ağırlık (Kg.) Weight (Kg.)	Fiyat Price
PTS04-MANUEL	⚡	230-380 / 50-60	6,4	40x60cm - 4 TEPSİ	80,5x83x57	68	1380 €
PTS04-DİJİTAL	⚡	230-380 / 50-60	6,4	40x60cm - 4 TEPSİ	80,5x83x57	68	1480 €
PTS06-MANUEL	⚡	380 / 50-60	10,4	40x60cm - 6 TEPSİ	80,5x87x103	120	1900 €
PTS06-DİJİTAL	⚡	380 / 50-60	10,4	40x60cm - 6 TEPSİ	80,5x87x103	120	2100 €
PTS09-MANUEL	⚡	380 / 50-60	15	40x60cm - 9 TEPSİ	80,5x87x135	180	3700 €
PTS09-DİJİTAL	⚡	380 / 50-60	15	40x60cm - 9 TEPSİ	80,5x87x135	180	3900 €

Konveksiyonel Fırınlar

Convection Ovens

Temel Özellikler

- Elektrikli modellerde monofaze veya trifaze besleme
- Gazlı modellerde LPG veya Doğalgaz ile çalışma
- Termostat kontrollü ısıtma
- Fanlı hava sirkülasyonu
- Nemlendirme
- Paslanmaz çelik gövde
- Isıya dayanıklı çift cam
- Pişirme zamanlayıcı
- Hijyenik ve emniyetli
- Uzun ömürlü

Basic Features

- Single-phase or three-phase supply in electric models
- Working with LPG or Natural Gas in gas models
- Thermostat controlled heating
- Fan air circulation
- Moistening
- Stainless steel body
- Heat resistant double glass
- Cooking timer
- Hygienic and safe
- Long lasting



DFKE06



DFKG10

Teknik Özellikler | Technical Features

Ürün Kodu Product Code	Enerji Tipi Energy Type	Gaz (Mbar,Volt) Gas (Mbar,Volt)	Güç (kW/kcal) Power (kW/kcal)	Kapasite (Tepsi-Adet) Capacity (Tray-Quantity)	Ebat (cm) Dimensions (cm)	Ağırlık (Kg.) Weight (Kg.)	Fiyat Price
DFKG10	🔥	21-25 / 30-50 / 220V	14	1/1 - 10 TEPSİ	95,5x77x105	124	4200 €
DFKG20	🔥	21-25 / 30-50 / 220V	18	1/1 - 20 TEPSİ	115,5x103x105	170	4900 €
DFKG40	🔥	21-25 / 30-50 / 220V	34	1/1 - 40 TEPSİ	115,5x109x178	200	5500 €

Ürün Kodu Product Code	Enerji Tipi Energy Type	Gerilim (Volt/Hz) Voltage (Volt/Hz)	Güç (kW) Power (kW)	Kapasite (Tepsi-Adet) Capacity (Tray-Quantity)	Ebat (cm) Dimensions (cm)	Ağırlık (Kg.) Weight (Kg.)	Fiyat Price
DFKE06	⚡	380 / 50-60	10,6	1/1 - 6 TEPSİ	95,5x86,6x82	90	2200 €
DFKE10	⚡	380 / 50-60	19,6	1/1 - 10 TEPSİ	95,5x86x105	140	3900 €
DFKE20	⚡	380 / 50-60	24,6	1/1 - 20 TEPSİ	115,5x102x105	160	4750 €
DFKE40	⚡	380 / 50-60	49,2	1/1 - 40 TEPSİ	115,5x108,5x177	200	5200 €

Döner Arabalı Ekmek Fırını (Gazlı)

Rotary Rack Oven (Gas)

Temel Özellikler

- Şık ve ergonomik tasarım
- Görsel sesli ikaz
- Döner Platformlu sistem
- Yüksek enerji tasarrufu
- Yüksek verimli Buhar Jeneratörleri
- Otomatik Buhar Kontrolü

Basic Features

- Stylish and ergonomic design
- Visual and audible warning
- Rotating platform - swing system
- High energy saving
- High efficiency powerfull steam generators
- Automatic steam control



Ürün Kodu Product Code	ROTA 810	ROTA 609	ROTA 608
Pişirme Kapasitesi (Adet) Baking Capacity (Pcs.)	3360	2016	1584
Tava Ölçüsü (cm) Baking Tray Size (cm)	80x100 / 75x104	60x90 / 60x80	60x90 / 60x80
Tava Adedi (Adet) Number of Trays (Pcs.)	14-16-18	14-16-18	14-16-18
Tava Arası Mesafeler (cm) Tray Clearances (cm)	11,4 - 10 - 8,9	11,4 - 10 - 8,9	12,5 - 10,5 - 9
Pişirme Alanı (m²) Baking Area (m ²)	11,2 - 12,8 - 14,4	7,56 - 8,64 - 9,72	5,94 - 7,02 - 8,01
Kapı Girişi (cm) Door Entrance (cm)	100	80	80
Baca Çıkışı (Ø) Chimney Outlet (Ø)	22	22	22
Buhar Baca Çıkışı Steam Extraction Pipe (Ø)	13	13	13
Su Girişi (Ø) Water Supply (inch)	1/2 "	1/2 "	1/2 "
Brülör Kapasitesi (kw) Burner Capacity (kw)	81/210	42/116	42/116
Enerji Kaynakları Energy Resource		Motorin, Doğalgaz, LNG, Katı Yakıtlar Gas-Oil, Solid Fuel	
Elektrik Bağlantısı Electric Connection		380 V / 50-60 hz / 3 Phase	
Bağlantı Gücü (kw) Power Supply (kw)	3,5	3,5	3,5
Isıl Güç (kcal/kw) Thermal Power (kcal/kw)	81700 / 95	60200 / 70	60200 / 70
Gaz Bağlantı Basıncı (Mbar) Gas Connection Pressure (Mbar)	21-300	21-300	21-300
Ağırlık Weight (Kg)	2650	225	1920
Dış Ölçüler (cm) Exterior Dimensions (cm)	191,5 x 232+30 x 260-300	171,5 x 232+30 x 227-273	171,5 x 207+30 x 227-273
Fiyat € Price €	40.800 €	36.000 €	34.200 €

Döner Arabalı Ekmek Fırını (Elektrikli)

Rotary Rack Oven (Electrical)

Temel Özellikler

- Şık ve ergonomik tasarım
- Görsel sesli ikaz
- Döner Platformlu sistem
- Yüksek enerji tasarrufu
- Yüksek verimli Buhar Jeneratörleri
- Otomatik Buhar Kontrolü

Basic Features

- Stylish and ergonomic design
- Visual and audible warning
- Rotating platform - swing system
- High energy saving
- High efficiency powerfull steam generators
- Automatic steam control

**Ürün Kodu**

Product Code

Pişirme Kapasitesi (Adet)

Baking Capacity (Pcs.)

Tava Ölçüsü (cm)

Baking Tray Size (cm)

Tava Adedi (Adet)

Number of Trays (Pcs.)

Tava Arası Mesafeler (cm)

Tray Clearances (cm)

Pişirme Alanı (m²)Baking Area (m²)**Kapı Girişi (cm)**

Door Entrance (cm)

Buhar Baca Çıkışı

Steam Extraction Pipe (Ø)

Su Girişi (Ø)

Water Supply (inch)

Enerji Kaynakları

Energy Resource

Elektrik Bağlantısı

Electric Connection

Bağlantı Gücü (kw)

Power Supply (kw)

Ağırlık Weight (Kg)

Weight (Kg)

Dış Ölçüler (cm)

Exterior Dimensions (cm)

Fiyat €

Price €

ROTA 810 E

3360

80x100 / 75x104

14-16-18

11,4 - 10 - 8,9

11,2 - 12,8 - 14,4

100

13

1/2 "

Elektrik / Electrical

380V / 50-60 hz / 3 phase

70

2100

181 x 232+25 x 215-260-290

37.800 €

ROTA 609 E

2016

60x90 / 60x80

14-16-18

11,4 - 10 - 8,9

7,56 - 8,64 - 9,72

80

13

1/2 "

Elektrik / Electrical

380V / 50-60 hz / 3 phase

57

1860

160 x 232+25 x 197-245-275

34.800 €

ROTA 608 E

1584

60x90 / 60x80

11-13-15

12,5 - 10,5 - 9

5,94 - 7,02 - 8,01

80

13

1/2 "

Elektrik / Electrical

380V / 50-60 hz / 3 phase

48

1500

160 x 207+25 x 197-245-275

32.400 €

Döner Konveksiyonlu Fırın

Rotary Convection Oven

Temel Özellikler

- Şık ve ergonomik tasarım
- Görsel sesli ikaz
- Döner Platformlu sistem
- Yüksek enerji tasarrufu
- Yüksek verimli Buhar Jeneratörleri
- Bağımsız, otomatik ısı ve nem kontrollü fermantasyon odası

Basic Features

- Stylish and ergonomic design
- Visual and audible warning
- Rotating platform - swing system
- High energy saving
- High efficiency powerfull steam generators
- Independent automatic temperature and humidity control in proofing chamber



Pişirme Hücresi | Baking Chamber

Ürün Kodu Product Code	STELLA 10E	STELLA 10G
Tava Ölçüsü (cm) Baking Tray Size (cm)	40 x 60	40 x 60
Tava Adedi (Adet) Number Of Tray (Pcs.)(cm)	10	10
Tava Arası Mesafe (cm) Tray Clearances (cm)	8,5	8,5
Piştirme Alanı (m ²) Baking Area of Deck (m ²)	2,4	2,4
Dış Ölçüler (cm) Exterior Dimension (cm)	100 x 108 x 140+10	100 x 145 x 140+10
Kapı Girişi (cm) Intake Opening (cm)	52	52
Buhar Baca Çıkışı (Ø cm) Steam Extraction Pipe (Ø cm)	9	9
Su Girişi (Inç) Water Supply (Inch)	1 / 2 "	1 / 2 "
Enerji Kaynağı Heating Type	Elektrikli / Electrical	Gazlı / Gas
Ağırlık (kg) Weight (kg)	350	390
Elektrik Bağlantısı Power Supply	380V / 50-60 hz / 3 phase	380V / 50-60 hz / 3 phase
Kontrol Sistemi Control System	Dijital / Digital	Dijital / Digital
Elektrik Gücü Power (kw)	23,5	3,5
Isıl Güç (kcal/kw) Thermal Power (kcal/kw)		16000 / 18

Fermantasyon Odası
Proofing Chamber

Tava Kapasitesi (Adet) Tray Capacity (Pcs.)	12	12
Tava Ölçüsü (cm) Tray Size (cm)	40 x 60	40 x 60
Dış Ölçüler (cm) Exterior Dimension (cm)	100 x 108 x72	100 x 108 x72
Elektrik Gücü (kw) Power (kw)	2,5	2,5
Ağırlık (kg) Weight (kg)	100	100
Toplam Ölçü (cm) Total Dimensions (cm)	100x108-30x212	100+22x145-195x210
Toplam Ağırlık (kg) Total Weight (kg)	350 + 100	390 + 100
Fiyat € Price €	19.800 €	23.400 €

Çok Amaçlı, Taş Tabanlı Fırınlar

Bakery and Pastry Ovens

Temel Özellikler

- Her kat birbirinden bağımsız çalışır.
- Katları taş tabanlı olduğundan ve seramik rezistanslar sayesinde ısıyı eşit olarak yayar.
- Sıcaklık kat içi alt, üst ve ön sıcaklığı her katta isteğe göre farklı ayarlanabilir.
- Düşük enerji tüketimi sağlar.

Basic Features

- Each deck can be operated independently.
- Temperature and the time of steam can be adjusted for each deck as per the request.
- Ceramic heaters provide homogenous heat distribution inside the oven as a result the cooking quality reaches the highest quality.
- It provides low energy consumption.



Ürün Kodu Product Code	Enerji Tipi Energy Type	Dış Ebat (cm) Outside Dim. (cm)	İç Ebat (cm) Inside Dim. (cm)	Güç (kW) Power (kW)	Gerilim (Volt) Voltage (Volt)	Ağırlık (Kg.) Weight (Kg.)	Fiyat Price
MT/1200/2	⚡	166 x 102 x 205	124 x 88 x 18	31,5	400	660	18250 €
MD/1200/2	⚡	166 x 102 x 185	124 x 88 x 18	21	400	385	13500 €
ME/1200/1	⚡	166 x 102 x 40	124 x 88 x 18	10,5	400	170	7150 €
MK/1200/T	⚡	162 x 90 x 70	124 x 88 x 18	3	400	105	2300 €
MK/1200/D	⚡	162 x 90 x 90	124 x 88 x 18	3	400	130	2550 €
PT/1200/D	⚡	162 x 88 x 90	-	-	400	70	1100 €
PT/1200/E	⚡	162 x 88 x 110	-	-	400	75	1150 €

Hamur Kesme-Tartma & Konik Yuvarlama Makinesi

Volumetric Dough Divider & Conical Rounder Machine

Hamur Kesme ve Tarma Temel Özellikler

- Hacimsel vakum kesme işlemi
- Gramaj hassasiyeti $\pm 5\%$
- Otomatik ayarlanabilir gramaj
- Paslanmaz kapak ve huni
- Hamur sayıcı
- Yükseklik ayarlı hamur çıkış konveyörü
- Unluk
- Hız kontrollü kesme

Volumetric Dough Divider Basic Features

- Volumetric suction divider;
- Weighing accuracy $\pm 5\%$
- Automatic adjustable weight;
- External and hopper stainless steel design
- Piece counter
- Height adjustable dough outfeed conveyor
- Flour duster
- Speed-controlled cutting

Konik Yuvarlama Temel Özellikler

- Sabit yuvarlama kolları
- Paslanmaz şasi
- Alüminyum döküm koni
- Paslanmaz kapak
- Hamur çıkış oluğu
- Unluk

Conical Rounder Basic Features

- Fixed rounding channels
- Stainless steel construction
- Cast aluminium cone
- Stainless steel cover design
- Discharge guide conveyor
- Flour duster



Teknik Özellikler | Technical Features

Hamur Kesme-Tartma Makinesi Volumetric Dough Divider	Ürün Kodu Product Code	VDD 70	VDD 90	VDD 110	VDD 130
	Ağırlık Hassasiyeti Weight Accuracy	$\pm 2\%$	$\pm 2\%$	$\pm 2\%$	$\pm 2\%$
	Hamur Kapasitesi(Kg.) Dough Feeding Capacity	60 kg.	60 kg.	60 kg.	60 kg.
	Hamur Parça Aralığı(gr.) Weight for Dough Pieces	50-150 gr.	80-400 gr.	100-600 gr.	250-1200 gr.
	Saat Başına kapasite Capacity per hour		1200 - 2400 Adet/Pieces		
	Boyutlar (mm) Dimensions		1557 x 640 x 1405		
	Ürün ağırlığı (Kg.) Product Weight		385		
	Motor gücü (kW) Motor Power		1,5		
	Voltaj(Volts/Hz.) Voltage		380V / 50-60 Hz		
	Fiyat € Price €	8650 €	8650 €	8650 €	8650 €

Konik Yuvarlama Makinesi Conical Rounder Divider	Ürün Kodu Product Code	CR 120	CR 240
	Hamur Ağırlığı (gr.) Weight of Dough-Pieces (Pcs.)	50 - 150 gr.	100 - 600 gr.
	Kapasite (Adet) Capacity (Pcs.)	Max. 2,500	Max. 2,500
	Ebat (mm) Dimensions (mm)	1580 x 940x 1010	1580 x 940x 1010
	Ürün Ağırlığı (Kg.) Product Weight (Kg.)	200	230
	Motor Gücü (kW) Motor Power (kW)	1,5	1,5
	Voltaj (Volts/Hz.) Voltage (Volts/Hz)	380V / 50-60Hz	380V / 50-60Hz
	Fiyat € Price €	5700 €	5700 €

Uzun Şekil Verme Makinesi

Long Moulder

Temel Özellikler

- Merkezi ayarlanabilir hamur giriş hunisi
- Katlanabilir ve kolay ayarlanabilir baskı tablası
- Hamur toplama tavası
- Kolay ayarlanabilir silindir aralığı ve baskı tablası yüksekliği
- Kazıyıcı silindirler
- Komple paslanmaz yapı
- Unlama haznesi

Basic Features

- Centrally adjustable dough infeed hopper
- Foldable and easy adjustable pressure board
- Collection tray
- Easy adjustable roller clearance and pressure board height
- Roller with scraper
- Completely stainless steel construction
- Flour chamber



Uzun Şekil Verme Makinesi | Long Moulder

Ürün Kodu

Product Code

LMM 200

Ruoll Sayısı (Adet)

Number of Rollers (Pcs)

2

Çalışma Genişliği (cm)

Working Width (cm)

47

Çalışma Boyu (cm)

Working Length (cm)

110

Ağırlık Aralığı (gr)

Weight Range (gr)

50-1500

Kapasite (Adet)

Capacity (Pcs)

Max 2500

Elektrik Bağlantısı (Volt/Hz)

Electric Connection (Volt/Hz)

380V / 50-60Hz

Güç kaynağı (kw)

Power Supply (kw)

0,55

Ağırlık (kg)

Weight (Kg)

310

Boyutlar (cm)

Dimensions (cm)

75 x 210 x125

Fiyat €

Price €

9700 €

Pizza Fırınları

Pizza Ovens

Temel Özellikler

- Paslanmaz çelik gövde
- Ateşe dayanıklı tuğla
- Hijyenik ve emniyetli
- Uzun ömürlü
- Gazlı modellerde LPG veya Doğalgaz ile çalışma
- Gazlı modellerde termostat kontrollü gaz modülü
- Elektrikli modellerde trifaze besleme
- Elektrikli modellerde termostat kontrollü ısıtma
- Elektrikli modellerde boru tipi rezistans ısıtıcı

Basic Features

- Stainless steel body
- Refractory brick
- Hygienic and safe
- Long lasting
- Working with LPG or Natural Gas in gas models
- Thermostat controlled gas module in gas models
- Three-phase supply in electric models
- Thermostat controlled heating in electric models
- Tubular resistance heater in electric models



M012-4



M014-4

Teknik Özellikler | Technical Features

Ürün Kodu Product Code	Enerji Tipi Energy Type	Gaz (Mbar,Volt) Gas (Mbar,Volt)	Güç (kW/kcal) Power (kW/kcal)	Kapasite (Adet) Capacity (Quantity)	İç Ebat (cm) Inner Dimensions (cm)	Ebat (cm) Dimensions (cm)	Ağırlık (Kg.) Weight (Kg.)	Fiyat Price
M013-4G	🔥	21-25 / 30-50	7,4/6364	4 LÜ	65x65	106,4x88x67	46	1470 €
M013-6G	🔥	21-25 / 30-50	9,6/8256	6 LI	96,5x65	137,5x88x67	62	1610 €

Ürün Kodu Product Code	Enerji Tipi Energy Type	Gerilim (Volt/Hz) Voltage (Volt/Hz)	Güç (kW) Power (kW)	Kapasite (Adet) Capacity (Quantity)	İç Ebat (cm) Inner Dimensions (cm)	Ebat (cm) Dimensions (cm)	Ağırlık (Kg.) Weight (Kg.)	Fiyat Price
M012-4	⚡	230-400 / 50-60	5	4 LÜ	62x62	90x82x50,5	80	780 €
M012-6	⚡	230-400 / 50-60	6	6 LI	92x62	120x82x50,5	106	960 €
M014-4	⚡	230-400 / 50-60	10	4+4 LÜ	62x62	90x82x80,5	120	1320 €
M014-6	⚡	230-400 / 50-60	12	6+6 LI	92x62	120x82x80,5	158	1620 €

Pasta & Börek Fırınları

Cake, Pastry Ovens



M016

Temel Özellikler

- Paslanmaz çelik gövde
- Gazlı modellerde paslanmaz boru tip brülör
- Gazlı modellerde tam veya kısık yanış seçeneği
- Gazlı modellerde LPG veya Doğalgaz ile çalışma
- Gazlı modellerde emniyet ventilli gaz musluğu
- Elektrikli modellerde trifaze besleme
- Elektrikli modellerde termostat kontrollü ısıtma
- Elektrikli modellerde boru tipi rezistans ısıtıcı
- Hijyenik, emniyetli ve uzun ömürlü

Basic Features

- Stainless steel body
- Stainless pipe type burner in gas models
- Full or low burning option in gas models
- Working with LPG or Natural Gas in gas models
- Gas valve with safety valve in gas models
- Three-phase feeding in electric models
- Thermostat controlled heating in electric models
- Tubular resistance heater in electric models
- Hygienic, safe and long lasting

Ürün Kodu Product Code	Enerji Tipi Energy Type	Gaz (Mbar,Volt) Gas (Mbar,Volt)	Güç (kW/kcal) Power (kW/kcal)	Kapasite (Adet) Capacity (Quantity)	Ebat (cm) Dimensions (cm)	Ağırlık (Kg.) Weight (Kg.)	Fiyat Price
M016	🔥	21-25 / 30-50	13/11180	5 TEPSİ	92X100X160	125	1190 €
Ürün Kodu Product Code	Enerji Tipi Energy Type	Gerilim (Volt/Hz) Voltage (Volt/Hz)	Güç (kW/) Power (kW/)	Kapasite (Adet) Capacity (Quantity)	Ebat (cm) Dimensions (cm)	Ağırlık (Kg.) Weight (Kg.)	Fiyat Price
M016E	⚡	380 / 50-60	10	5 TEPSİ	90X100X160	123	1900 €

Üç Katlı Elektrikli Fırın

Three Deck Electric Oven



Temel Özellikler

- Paslanmaz çelik gövde
- Hijyenik ve emniyetli
- Uzun ömürlü
- Trifaze besleme
- Termostat kontrollü ısıtma
- Boru tipi rezistans ısıtıcı

Basic Features

- Stainless steel body
- Hygienic and safe
- Long lasting
- Three-phase supply
- Thermostat controlled heating
- Tubular resistance heater

Ürün Kodu Product Code	Enerji Tipi Energy Type	Gerilim (Volt/Hz) Voltage (Volt/Hz)	Güç (kW/) Power (kW/)	Kapasite(Raf Ebat/Adet) Capacity (Raf Ebat / Quantity)	Ebat (cm) Dimensions (cm)	Ağırlık (Kg.) Weight (Kg.)	Fiyat Price
MM.B0002	⚡	230 / 50-60	15	62 x 60cm / 6 (2x3)	95x90x158	235	4400 €

Mayalandırma Kabini

Fermentation Cabinet

Temel Özellikleri

- Monofaze veya trifaze besleme voltajı
- İç aydınlatma
- 0/60 ısı kontrol
- Homojen ısı dağılımı
- Mayalı unlu mamüllerin mayalanması için kullanılır
- Hijyenik ve emniyetli
- Uzun ömürlü

Basic Features

- Single-phase or three-phase supply voltage
- Interior lighting
- 0/60 temperature control
- Homogeneous heat distribution
- Used for fermenting yeast bakery products
- Hygienic and safe
- Long lasting



MYK1

Teknik Özellikler | Technical Features

Ürün Kodu / Adı Product Code / Name	Enerji Tipi Energy Type	Gerilim (Volt/Hz) Voltage (Volt/Hz)	Güç (kW/) Power (kW/)	Kapasite (Tepsi-Adet) Capacity (Tray-Quantity)	Ebat (cm) Dimensions (cm)	Ağırlık (Kg.) Weight (Kg.)	Fiyat Price
MYK1	⚡	-	-	40x60cm - 10 TEPSİ	90,5x85x90	91	770 €
MYK2	⚡	-	-	40x60cm - 20 TEPSİ	90,5x110x90	-	840 €

Fırın Komponentleri

Oven Components



Teknik Özellikler | Technical Features

Ürün Kodu / Adı Product Code / Name	Enerji Tipi Energy Type	Gerilim (Volt/Hz) Voltage (Volt/Hz)	Güç (kW/) Power (kW/)	Kapasite (Tepsi-Adet) Capacity (Tray-Quantity)	Ebat (cm) Dimensions (cm)	Ağırlık (Kg.) Weight (Kg.)	Fiyat Price
ALTSND06	-	-	-	6 TEPSİ	-	-	350 €
ALTSND10	-	-	-	10 TEPSİ	-	-	420 €
ALTSND20	-	-	-	20 TEPSİ	-	-	490 €
T. TAŞIMA RAFI	-	-	-	-	-	-	630 €
T. TAŞIMA ARABASI	-	-	-	-	-	-	180 €

Kumpir Fırınları

Potato Ovens

Gazlı

- LPG veya Doğalgaz ile çalışma
- Emniyet ventilli gaz musluğu
- Paslanmaz çelik çekmeceler
- Elektrostatik boyalı gövde
- Tam veya kısık yanış seçeneği
- Hijyenik ve emniyetli
- Uzun ömürlü

Temel Özellikler

- Monofaze veya trifaze besleme voltajı
- İki kademeli ısıtma
- Boru tipi rezistans ısıtıcı
- Paslanmaz çelik çekmeceler
- Elektrostatik boyalı gövde
- Tam veya kısık yanış seçeneği
- Hijyenik ve emniyetli
- Uzun ömürlü

Elektrikli

Gas

- LPG or Natural Gas usage
- Faucet with safety valve
- Stainless steel drawers
- Electrostatically painted body
- Adjustable burner capacity
- Hygienic and safe
- Long life cycle

Basic Features

- Single or three phase supply voltage
- Two-stage heating
- Tube type resistance heater
- Stainless steel drawers
- Electrostatically painted body
- Adjustable burner capacity
- Hygienic and safe
- Long life cycle

Electrical



M079-2E



M079-3E



KF-M079-4G

Teknik Özellikler | Technical Features

Ürün Kodu Product Code	Enerji Tipi Energy Type	Gaz (Mbar,Volt) Gas (Mbar,Volt)	Güç (kW/kcal) Power (kW/kcal)	Kapasite (Çekmece) Capacity (Drawer)	Ebat (cm) Dimensions (cm)	Ağırlık (Kg.) Weight (Kg.)	Fiyat Price
KF-M079-2G	🔥	21-25 / 30-50	4 / 3440	2	46,5X54X92	48	670 €
KF-M079-3G	🔥	21-25 / 30-50	4 / 3440	3	46,5X54X110	59	810 €
KF-M079-4G	🔥	21-25 / 30-50	4 / 3440	4	46,5X54X120	68	880 €

Ürün Kodu Product Code	Enerji Tipi Energy Type	Gerilim (Volt/Hz) Voltage (Volt/Hz)	Güç (kW/) Power (kW/)	Kapasite (Çekmece) Capacity (Drawer)	Ebat (cm) Dimensions (cm)	Ağırlık (Kg.) Weight (Kg.)	Fiyat Price
M079-2E	⚡	230-400 / 50-60	3	2	48x55x89	50	770 €
M079-3E	⚡	230-400 / 50-60	4,5	3	48x55x105	60	840 €
M079-4E	⚡	230-400 / 50-60	6	4	48x55x125	70	910 €



Döner Makinaları

Shawarma Machines

Döner Makinaları
Doner Machines

Döner Makinaları

Shawarma Machines

Ekonomik Model Döner Makinaları & Dönerli Kebab Makinası

Economic Type Shawarma Machines & Rotary Kebab Machine

Ekonomik Model Temel Özellikler

- LPG veya Doğalgaz ile çalışma
- Emniyet ventilli gaz musluğu
- Paslanmaz çelik gövde ve şiş
- 1,2,3,4 veya 5 Radyanlı ısıtıcı
- Ayarlanabilir yanma kapasitesi
- Hijyenik ve emniyetli

Economic Type Basic Features

- Working with LPG or Natural Gas
- Gas valve with safety valve
- Stainless steel body and skewer
- 1,2,3,4 or 5 Radian heater
- Adjustable burning capacity
- Hygienic and safe



D07/M76



Adana Kebab Mak
Turkish Kebab Mach.
BKS.100



M077-4AK

Teknik Özellikler | Technical Features

Ürün Kodu Product Code	Enerji Tipi Energy Type	Gaz (Mbar) Gas (Mbar)	Güç (kW/kcal) Power (kW/kcal)	Kapasite Capacity	Ebat (cm) Dimensions (cm)	Ağırlık (Kg.) Weight (Kg.)	Motor Gücü (Volt/Watt) Motor Power (Volt/Watt)	Fiyat Price
D05/M73	🔥	21/25-30/50	6,5/5590	2 Radyan / Radian	47x52x67	18	-	350 €
D06/M75	🔥	21/25-30/50	9,75/8385	3 Radyan / Radian	47x50x95	20	-	390 €
D07/M76	🔥	21/25-30/50	13/11180	4 Radyan / Radian	47x52x105	27	-	420 €
D08/M78	🔥	21/25-30/50	16,25/13795	5 Radyan / Radian	47x52x120	30	-	460 €
M077-4AK	🔥	21/25-30/50	13/11180	17 Şiş / Skewer	70x57x118	49	230 / 26	1100 €
BKS.100	Adana Kebab Mak. Adana Kebab Mach. ⚡	-	-	60 Gr. - 100 Gr.	21x37x73	20	220 / 30	1030 €

Üstten Motorlu & Altan Motorlu Döner Makinaları

Shawarma Machines With Top Motor & Shawarma Machines With Bottom Motor

Temel Özellikler

- LPG veya Doğalgaz ile çalışma
- Emniyet ventilli gaz musluğu
- Paslanmaz çelik gövde ve şiş
- 1,2,3,4 veya 5 Radyanlı ısıtıcı
- Ayarlanabilir yanma kapasitesi
- Uzun ömürlü
- Hijyenik ve emniyetli
- Üstten motorlu döner makinalarında ayarlanabilir şiş mesafesi

Basic Features

- Working with LPG or Natural Gas
- Gas valve with safety valve
- Stainless steel body and skewer
- 1,2,3,4 or 5 Radian heater
- Adjustable burning capacity
- Long lasting
- Hygienic and safe
- Adjustable skew distance on top motor rotary machines



DO7/M77-1(4P)



DO7/M77-(4A)

Teknik Özellikler | Technical Features

Ürün Kodu Product Code	Enerji Tipi Energy Type	Gaz (Mbar) Gas (Mbar)	Güç (kW/kcal) Power (kW/kcal)	Kapasite (Radyan) Capacity (Radyan)	Ebat (cm) Dimensions (cm)	Ağırlık (Kg.) Weight (Kg.)	Motor Gücü (Volt/Watt) Motor Power (Volt/Watt)	Fiyat Price
DO7/M77-1(4P)	🔥	21/25-30/50	13/11180	4	47x75x117	40	230 / 26	670 €
DO8/M77-1(5P)	🔥	21/25-30/50	16,25/13975	5	47x75x135	44	230 / 26	690 €
DO6/M77-(3A)	🔥	21/25-30/50	9,75/8385	3	71x50x80	40	230 / 26	800 €
DO7/M77-(4A)	🔥	21/25-30/50	13/11180	4	50x71x105	45	230 / 26	880 €
DO8/M77-(5A)	🔥	21/25-30/50	16,25/13975	5	50x71x110	52	230 / 26	960 €

Döner Makinaları

Shawarma Machines

V Tipi Altan Motorlu & Altan Motorlu Çiftli Döner Makinaları

V-Type Shawarma Machines & Double Shawarma Machine with Bottom Motor

Temel Özellikler

- LPG veya Doğalgaz ile çalışma
- Paslanmaz çelik gövde ve şiş
- Uzun ömürlü
- Hijyenik ve emniyetli
- Emniyet ventilli gaz musluğu
- V Tipi Modellerde 3,4 veya 5 radyanlı ısıtıcı
- Çiftli Modellerde 3+3, 4+4, 5+5 radyanlı ısıtıcı
- Ayarlanabilir yanma kapasitesi
- Alt motorlu veya motorsuz

Basic Features

- Working with LPG or Natural Gas
- Stainless steel body and skewer
- Long lasting
- Hygienic and safe
- Gas valve with safety valve
- 3, 4 or 5 radiant heater in V-Type models
- 3+3, 4+4 or 5+5 radiant heater in double models
- Adjustable combustion capacity
- With or without bottom motor



DO1/M077-4V



DO1/M77-4+4

Teknik Özellikler | Technical Features

Ürün Kodu Product Code	Enerji Tipi Energy Type	Gaz (Mbar) Gas (Mbar)	Güç (kW/kcal) Power (kW/kcal)	Kapasite (Radyan) Capacity (Radyan)	Ebat (cm) Dimensions (cm)	Ağırlık (Kg.) Weight (Kg.)	Motor Gücü (Volt/Watt) Motor Power (Volt/Watt)	Fiyat Price
DO1/M077-4V	🔥	21/25-30/50	26/22360	4+4	72x90x110	68	230 / 26	1470 €
DO2/M077-5V	🔥	21/25-30/50	32,5/27950	5+5	72x90x125	72	230 / 26	1610 €
DO1/M77-4+4	🔥	21/25-30/50	26/22360	4+4	72x90x110	78	230 / 26	1680 €
DO2/M77-5+5	🔥	21/25-30/50	32,5/27950	5+5	72x90x125	82	230 / 26	1750 €

Otomatik Döner Robotları & Arabalı Döner Makinası

Automatic Shawarma Machines & Shawarma Machine at Trolley

Otomatik Döner Robotu Temel Özellikler

- LPG veya Doğalgaz ile çalışma
- Paslanmaz çelik gövde ve şiş
- Uzun ömürlü
- Hijyenik ve emniyetli
- Alt motorlu
- Kesintisiz çalışma
- Düşük enerji tüketimi
- Hassas kalınlıkta kesim
- Sökülebilir bıçak (çap 140mm)
- Elektrik kesintisinde manuel kullanma

Automatic Shawarma Basic Features

- Working with LPG or Natural Gas
- Stainless steel body and skewer
- Long lasting
- Hygienic and safe
- Sub motor
- Continuous operation
- Low energy consumption
- Precise thickness cutting
- Detachable blade (diameter 140mm)
- Manual in power failure



RBT-M077-4



DO8/M077-X5

Teknik Özellikler | Technical Features

Ürün Kodu Product Code	Enerji Tipi Energy Type	Gaz (Mbar) Gas (Mbar)	Güç (kW/kcal) Power (kW/kcal)	Kapasite (Radyan) Capacity (Radyan)	Ebat (cm) Dimensions (cm)	Ağırlık (Kg.) Weight (Kg.)	Fiyat Price
RBT/M077-4	🔥	21/25-30/50	13/11180	4	90x95x180	170	16.500 €
RBT/M077-5	🔥	21/25-30/50	16,25/13975	5	90x95x200	180	18.500 €
RBT/M077-5V	🔥	21/25-30/50	32,5/27950	5+5	135x120x200	300	21.000 €
DO7/M077-X4 (Arabalı)	🔥	21/25-30/50	13/11180	4	70x80x165	105	3400 €
DO8/M077-X5 (Arabalı)	🔥	21/25-30/50	16,25/27590	5	70x80x180	110	3600 €
DO1/M077-X4+4 (Arabalı)	🔥	21/25-30/50	26/22360	4+4	90x100x165	116	4400 €
DO2/M077-X5+5 (Arabalı)	🔥	21/25-30/50	32,5/27950	5+5	90x100x180	120	4600 €

Döner Makinaları

Shawarma Machines

Elektrikli Alttan Motorlu & Üstten Motorlu, Camlı Döner Makinaları

Electrical Shawarma Machines with Bottom Motor & Top Motor

Temel Özellikler

- Monofaze veya trifaze elektrik besleme
- Paslanmaz çelik gövde ve şiş
- 3, 4 veya 5 tel rezistans ısıtıcı
- 2 kademeli ısıtma
- Hijyenik ve emniyetli ve uzun ömürlü
- Şiş döndürme mekanizması
- Üstten motorlu camlı makinalarda ayarlanabilir şiş mesafesi

Basic Features

- Single-phase or three-phase electricity supply
- Stainless steel body and skewer
- 3, 4 or 5 wire resistance heater
- 2-stage heating
- Hygienic and safe and long-lasting
- Skewer mechanism
- Adjustable skew distance on top motorized glass machines



M077-4C



M077-4E

Teknik Özellikler | Technical Features

Ürün Kodu Product Code	Enerji Tipi Energy Type	Gerilim (Volt/Hz) Voltage (Volt/Hz)	Güç (kW/) Power (kW/)	Kapasite (Radyan) Capacity (Radyan)	Ebat (cm) Dimensions (cm)	Ağırlık (Kg.) Weight (Kg.)	Motor Gücü (Volt/Watt) Motor Power (Volt/Watt)	Fiyat Price
M077-3C	⚡	230-400 / 50-60	4,8	3	50x70x92	50	230 /14	950 €
M077-4C	⚡	230-400 / 50-60	6,4	4	50x70x115	52	230 /14	980 €
M077-3E	⚡	230-400 / 50-60	4,8	3	50x71x92	55	230 /14	980 €
M077-4E	⚡	230-400 / 50-60	6,4	4	50x71x115	60	230 /14	1050 €

Kömürlü, Dökümlü & Elektrikli Üstten Motorlu Döner Makinaları

Coal Heated Shawarma Machines & Electrical Shawarma Machines with Top Motor

Kömürlü Model Temel Özellikler

- Kömür ateşi ile pişirme
- Paslanmaz çelik gövde ve şiş
- 3, 4 veya 5 ısıtıcı göz
- Tutuşturma brülörü
- Hijyenik ve emniyetli,
- Uzun ömürlü
- Sabit alt tabla

Coal Heated Model Basic Features

- Coal fire burning
- Stainless steel body and skewer
- 3, 4 or 5 heating drawer
- Pipe type burner for ignition
- Hygienic and safe
- Long life eyde
- Fixed bottom fable

Elektrikli Üstten Motorlu Temel Özellikler

- Monofaze veya trifaze elektrik besleme
- Paslanmaz çelik gövde ve şiş
- 3, 4 veya 5 tel rezistans ısıtıcı
- 2 kademeli ısıtma
- Hijyenik ve emniyetli ve uzun ömürlü
- Şiş döndürme mekanizması
- Üstten motorlu camlı makinalarda ayarlanabilir şiş mesafesi

Electrical, Top Motor Basic Features

- Single-phase or three-phase electricity supply
- Stainless steel body and skewer
- 3, 4 or 5 wire resistance heater
- 2-stage heating
- Hygienic and safe and long-lasting
- Skewer mechanism
- Adjustable skew distance on top motorized glass machines

**M077-K4****M077-4D****Teknik Özellikler | Technical Features**

Ürün Kodu Product Code	Enerji Tipi Energy Type	Gaz (Mbar) Gas (Mbar)	Güç (kW/kcal) Power (kW/kcal)	Kapasite (Radyan) Capacity (Radyan)	Ebat (cm) Dimensions (cm)	Ağırlık (Kg.) Weight (Kg.)	Motor Gücü (Volt/Watt) Motor Power (Volt/Watt)	Fiyat Price
M077-K3		-	-	3	50X60X95	72	-	1000 €
M077-K4		-	-	4	50X60X95	82	-	1100 €
Ürün Kodu Product Code	Enerji Tipi Energy Type	Gerilim (Volt/Hz) Voltage (Volt/Hz)	Güç (kW/) Power (kW/)	Kapasite (Radyan) Capacity (Radyan)	Ebat (cm) Dimensions (cm)	Ağırlık (Kg.) Weight (Kg.)	Motor Gücü (Volt/Watt) Motor Power (Volt/Watt)	Fiyat Price
M077-3D		230-400 / 50-60	8,1	6	50X60X92	62	230 /14	910 €
M077-4D		230-400 / 50-60	10,8	8	50x60x105	65	230 /14	980 €

Döner Makinaları

Shawarma Machines

Döner Bıçağı, Radyanlar & Brülörler

V-Type Shawarma Machines & Automatic Shawarma Machines



A1 Radyan

Ölçüler (mm)	Güç	Gas Tipi	Önerilen Gaz Basıncı	Çerçeve Malzemesi	Kapak Örgüsü	Gas Girişi	Net Ağırlık
235x175x100	3,25 Kw	Metan, Lpg	Metan 20 / Lpg 50 (mbar)	Galvanizli Sac	Paslanmaz Presli Elek Sac	1/4 inch Bakır Boru	1600 Gr.
Dimensions (mm)	Power	Gas Type	Recommended Gas Pressure	Frame Material	Cap Mesh	Gas Inlet	Net Weight
235x175x100	3,25 Kw	Metan, Lpg	Metan 20 / Lpg 50 (mbar)	Galvanized Sheet Metal	Stainless caged sheet metal with press	1/4 inch Copper Pipe	1600 Gr.

- A01 radyanın yanıcı yüzeyi seramik malzemeden yapılmıştır.
Burner surface of A1 radiant is made from ceramic materials.

10€



B1 Radyan

Ölçüler (mm)	Güç	Gas Tipi	Önerilen Gaz Basıncı	Çerçeve Malzemesi	Kapak Örgüsü	Gas Girişi	Net Ağırlık
240x175x70	3,25 Kw	Metan, Lpg	Metan 20 / Lpg 50 (mbar)	Galvanizli Sac	Paslanmaz Presli Elek Sac	1/4 inch Bakır Boru	1600 Gr.
Dimensions (mm)	Power	Gas Type	Recommended Gas Pressure	Frame Material	Cap Mesh	Gas Inlet	Net Weight
235x175x100	3,25 Kw	Metan, Lpg	Metan 20 / Lpg 50 (mbar)	Galvanized Sheet Metal	Stainless caged sheet metal with press	1/4 inch Copper Pipe	1300 Gr.

- B1 radyanın yanıcı yüzeyi seramik malzemeden yapılmıştır.
Burner surface of B1 radiant is made from ceramic materials.

12€



Fransız Radyan

Ölçüler (mm)	Güç	Gas Tipi	Önerilen Gaz Basıncı	Çerçeve Malzemesi	Kapak Örgüsü	Gas Girişi	Net Ağırlık
235x175x100	3,25 Kw	Metan, Lpg	Metan 20 / Lpg 50 (mbar)	Galvanizli Sac	Paslanmaz Presli Elek Sac	1/4 inch Bakır Boru	1600 Gr.
Dimensions (mm)	Power	Gas Type	Recommended Gas Pressure	Frame Material	Cap Mesh	Gas Inlet	Net Weight
235x175x100	3,25 Kw	Metan, Lpg	Metan 20 / Lpg 50 (mbar)	Galvanized Sheet Metal	Stainless caged sheet metal with press	1/4 inch Copper Pipe	1600 Gr.

- Fransız radyanın yanıcı yüzeyi seramik malzemeden yapılmıştır.
Burner surface of French radiant is made from ceramic materials.

34€



Borulu Radyan

Ölçüler (mm)	Güç	Gas Tipi	Önerilen Gaz Basıncı	Çerçeve Malzemesi	Kapak Örgüsü	Gas Girişi	Net Ağırlık
235x175x100	3,25 Kw	Metan, Lpg	Metan 20 / Lpg 50 (mbar)	Emayeli Sac	Paslanmaz Presli Elek Sac	1/4 inch Bakır Boru	1600 Gr.
Dimensions (mm)	Power	Gas Type	Recommended Gas Pressure	Frame Material	Cap Mesh	Gas Inlet	Net Weight
235x175x100	3,25 Kw	Metan, Lpg	Metan 20 / Lpg 50 (mbar)	Enamelled Sheet Metal	Stainless caged sheet metal	1/4 inch Copper Pipe	1600 Gr.

- Emayeli borulu radyanın yanıcı yüzeyi seramik malzemeden yapılmıştır.
Burner surface of enamelled radiant is made from ceramic materials.

16€



Motorlu Döner Bıçağı

Energy Type Enerji Türü	Code Kod No	Total Power Toplam Güç Kw	Ağırlık Weight Kg	Motor Motor Volt - Watt	Fiyat Price
⚡	MTB	3x16	2	230 - 15	450€



Manuel Döner Bıçağı 20€



Piliç Çevirme Makineleri

Chicken Rotisserie Machines

Piliç Çevirme
Chicken Rotisserie

Piliç Çevirme Makineleri

Chicken Rotisserie Machines

Setüstü Piliç Çevirme Makineleri

Set Model Chicken Grilled Machines

Gazlı

- LPG veya doğalgaz ile çalışma
- Emniyet ventilli gaz musluğu
- Paslanmaz çelik gövde ve şiş
- 2-3 radyan ısıtıcı
- Hijyenik, emniyetli, ısıya dayanıklı cam
- Motorlu şiş döndürme mekanizması

Temel Özellikler

- Monofaze veya trifaze elektrik besleme
- 2 kademeli ısınma
- Paslanmaz çelik gövde ve şiş
- Boru tipi rezistans
- Hijyenik, emniyetli, ısıya dayanıklı cam
- Motorlu şiş döndürme mekanizması

Elektrikli

Gas

- LPG or Natural gas usage
- Faucet with safety valve
- Stainless steel body and skewer
- 2-3 radiant burner
- Hygienic and safe with pyrex glass
- Electric motor driven skewer mechanism

Basic Features

- Single or three phase supply voltage
- Two-stage heating
- Stainless steel body and skewer
- Tube type resistances
- Hygienic and safe with pyrex glass
- Electric motor driven skewer mechanism

Electrical

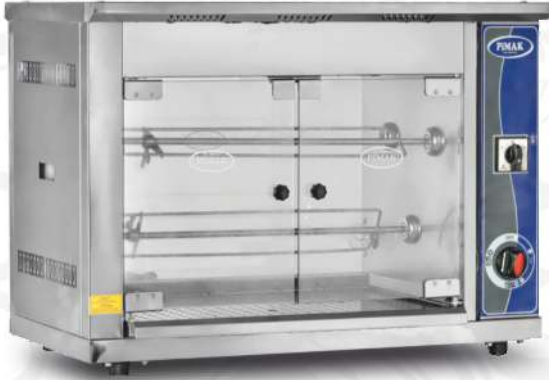

M002-E



M003-E

Teknik Özellikler | Technical Features

Ürün Kodu Product Code	Enerji Tipi Energy Type	Gaz (Mbar) Gas (Mbar)	Güç (kW/kcal) Power (kW/kcal)	Kapasite (Şiş/Piliç) Capacity (Skewer/Chicken)	Ebat (cm) Dimensions (cm)	Ağırlık (Kg.) Weight (Kg.)	Motor Gücü (Volt/Watt) Motor Power (Volt/Watt)	Fiyat Price
PI/M001	🔥	21/25-30/50	5/4300	2/6	72x50x65	47	230 /22	670 €
PI/M002	🔥	21/25-30/50	5/4300	3/9	79x50x65	51	230 /22	770 €
M003	🔥	21/25-30/50	7,5/6450	3/12	88x50x65	53	230 /22	880 €
M004	🔥	21/25-30/50	7,5/6450	3/15	103x50x65	55	230 /22	980 €

Ürün Kodu Product Code	Enerji Tipi Energy Type	Gerilim (Volt/Hz) Voltage (Volt/Hz)	Güç (kW/) Power (kW/)	Kapasite (Şiş/Piliç) Capacity (Skewer/Chicken)	Ebat (cm) Dimensions (cm)	Ağırlık (Kg.) Weight (Kg.)	Motor Gücü (Volt/Watt) Motor Power (Volt/Watt)	Fiyat Price
M001-E	⚡	230-400 / 50-60	4	2/6	72x50x65	50	230 /22	670 €
M002-E	⚡	230-400 / 50-60	4	3/9	79x50x65	54	230 /22	770 €
M003-E	⚡	230-400 / 50-60	4	3/12	88x50x65	56	230 /22	880 €
M004-E	⚡	230-400 / 50-60	4,5	3/15	103x50x65	58	230 /22	980 €

Setüstü Tamburlu Piliç Makineleri

Set Top, Drum Chicken Machines

Gazlı

- LPG veya doğalgaz ile çalışma
- Emniyet ventilli gaz musluğu
- Paslanmaz çelik gövde ve şiş
- Radyan veya boru brülörlü ısıtıcı
- Hijyenik, emniyetli, ısıya dayanıklı cam
- Motorlu şiş döndürme mekanizması

Temel Özellikler

- Monofaze veya trifaze elektrik besleme
- 2 kademeli ısınma
- Paslanmaz çelik gövde ve şiş
- Boru tipi rezistans
- Hijyenik, emniyetli, ısıya dayanıklı cam
- Motorlu şiş döndürme mekanizması

Elektrikli

Gas

- LPG or Natural gas usage
- Faucet with safety valve
- Stainless steel body and skewer
- Radiant or Pipe Type burner
- Hygienic and safewith pyrex glass
- Electric motor driven skewer mechanism

Basic Features

- Single or three phase supply voltage
- Two-stage heating
- Stainless steel body and skewer
- Tube type resistances
- Hygienic and safewith pyrex glass
- Electric motor driven skewer mechanism

Electrical



PI2/M006



M00-T

Teşhir Ünitesi | Display Unit

Teknik Özellikler | Technical Features

Ürün Kodu Product Code	Enerji Tipi Energy Type	Gaz (Mbar) Gas (Mbar)	Güç (kW/kcal) Power (kW/kcal)	Kapasite (Şiş/Piliç) Capacity (Skewer/Chicken)	Ebat (cm) Dimensions (cm)	Ağırlık (Kg.) Weight (Kg.)	Motor Gücü (Volt/Watt) Motor Power (Volt/Watt)	Fiyat Price
P11/M005	🔥	21/25-30/50	5/6450	5/20	90x60x104	95	230 /40	1610 €
P12/M006	🔥	21/25-30/50	8/6880	5/25	107x60x104	106	230 /40	1720 €

Ürün Kodu Product Code	Enerji Tipi Energy Type	Gerilim (Volt/Hz) Voltage (Volt/Hz)	Güç (kW/) Power (kW/)	Kapasite (Şiş/Piliç) Capacity (Skewer/Chicken)	Ebat (cm) Dimensions (cm)	Ağırlık (Kg.) Weight (Kg.)	Motor Gücü (Volt/Watt) Motor Power (Volt/Watt)	Fiyat Price
M005-E	⚡	230-400 / 50-60	6	5/20	90x60x104	95	230 /40	1610 €
M006-E	⚡	230-400 / 50-60	7	6/25	107x60x104	101	230 /40	1720 €

Ürün Kodu Product Code	Enerji Tipi Energy Type	Gerilim (Volt/Hz) Voltage (Volt/Hz)	Güç (kW) Power (kW)	Kapasite (Piliç) Capacity (Chicken)	Ebat (cm) Dimensions (cm)	Ağırlık (Kg.) Weight (Kg.)	Fiyat Price
M00-T	⚡	230-400 / 50-60	-	12-20	81 x 66 x 78	58	900 €

Piliç Çevirme Makineleri

Chicken Rotisserie Machines

Tamburlu Dinlendirmeli & Çift Katlı Tamburlu Piliç Makineleri

Drum Type, Warm Display & Drum Type Double Part Chicken Grills

Gazlı

- LPG veya Doğalgaz ile çalışma
- Emniyet ventilli gaz musluğu
- Radyan veya boru brülörlü ısıtıcı
- Ayarlanabilir yanma kapasitesi
- Paslanmaz çelik gövde ve şiş
- Hijyenik, emniyetli, ısıya dayanıklı cam
- Motorlu şiş döndürme mekanizması
- Tamburlu modellerde sıcak dinlendirme ünitesi
- Çift taraflı vitrin

Temel Özellikler

- Monofaze veya trifaze elektrik besleme
- İki kademeli ısıtma
- Boru tipi rezistans
- Paslanmaz çelik gövde ve şiş
- Hijyenik, emniyetli, ısıya dayanıklı cam
- Motorlu şiş döndürme mekanizması
- Tamburlu modellerde sıcak dinlendirme ünitesi
- Çift taraflı vitrin

Elektrikli

Gas

- Working with LPG or Natural Gas
- Gas valve with safety valve
- Radiant or pipe burner heater
- Adjustable burning capacity
- Stainless steel body and skewer
- Hygienic, safe, heat-resistant glass
- Motorized skewer mechanism
- Hot resting unit in drum rest models
- Double-sided showcase

Basic Features

- Single-phase or three-phase electricity supply
- Two-stage heating
- Tube type resistance
- Stainless steel body and skewer
- Hygienic, safe, heat-resistant glass
- Motorized skewer mechanism
- Hot resting unit in drum rest models
- Double-sided showcase

Electrical



PI2/M008B



M008-E

Teknik Özellikler | Technical Features

Ürün Kodu Product Code	Enerji Tipi Energy Type	Gaz (Mbar) Gas (Mbar)	Güç (kW/kcal) Power (kW/kcal)	Kapasite (Şiş/Piliç) Capacity (Skewer/Chicken)	Ebat (cm) Dimensions (cm)	Ağırlık (Kg.) Weight (Kg.)	Motor Gücü (Volt/Watt) Motor Power (Volt/Watt)	Fiyat Price
PI1/M007B	🔥	21/25-30/50	7,5/6450	5/20	92x60x170	138	230 / 40	2450 €
PI2/M008B	🔥	21/25-30/50	8/6880	5/25	107x60x170	138	230 / 40	2650 €
PI3/M009	🔥	21/25-30/50	16/13760	5+5/20+20	92x60x190	160	230 / 40	3000 €
PI4/M009B	🔥	21/25-30/50	16/13760	5+5/25+25	107x60x190	170	230 / 40	3200 €
Ürün Kodu Product Code	Enerji Tipi Energy Type	Gerilim (Volt/Hz) Voltage (Volt/Hz)	Güç (kW/) Power (kW/)	Kapasite (Şiş/Piliç) Capacity (Skewer/Chicken)	Ebat (cm) Dimensions (cm)	Ağırlık (Kg.) Weight (Kg.)	Motor Gücü (Volt/Watt) Motor Power (Volt/Watt)	Fiyat Price
M007-E	⚡	230-400 / 50-60	8,5	5/20	92x60x170	122	230 / 40	2450 €
M008-E	⚡	230-400 / 50-60	9,5	5/25	107x60x170	130	230 / 40	2650 €
M009-E	⚡	230-400 / 50-60	14	5+5/20+20	92x60x190	140	230 / 40	3000 €
M009B-E	⚡	230-400 / 50-60	14	5+5/25+25	107x60x190	153	230 / 40	3200 €

Çift Vitrinli Lavtaşlı Piliç Makineleri

Double Showcase, Chicken Machines with Lava Stone

**PI3/M010B****Temel Özellikler**

- LPG veya Doğalgaz ile çalışma
- Emniyet ventilli gaz musluğu
- Boru brülörlü ısıtıcı
- Ayarlanabilir yanma kapasitesi
- Paslanmaz çelik gövde ve şiş
- Hijyenik, emniyetli, ısıya dayanıklı cam
- Motorlu şiş döndürme mekanizması
- Çift taraflı vitrin

Basic Features

- Working with LPG or Natural Gas
- Gas valve with safety valve
- Pipe burner heater
- Adjustable burning capacity
- Stainless steel body and skewer
- Hygienic, safe, heat-resistant glass
- Motorized skewer mechanism
- Double-sided showcase

Teknik Özellikler | Technical Features

Ürün Kodu Product Code	Enerji Tipi Energy Type	Gaz (Mbar) Gas (Mbar)	Güç (kW/kcal) Power (kW/kcal)	Kapasite (Şiş/Piliç) Capacity (Skewer/Chicken)	Ebat (cm) Dimensions (cm)	Ağırlık (Kg.) Weight (Kg.)	Motor Gücü (Volt/Watt) Motor Power (Volt/Watt)	Fiyat Price
PI3/M010B	🔥	21/25-30/50	16/13760	12/48	90X60X190	164	230 / 40	3200 €
PI4/M011B	🔥	21/25-30/50	16/13760	12/60	105X60X190	186	230 / 40	3400 €

Dökümlü Piliç Çevirme Makineleri

Chicken Grills Machines With Cast

**PI5/M015B****Temel Özellikler**

- LPG veya Doğalgaz ile çalışma
- Emniyet ventilli gaz musluğu
- Boru brülörlü ısıtıcı
- Ayarlanabilir yanma kapasitesi
- Paslanmaz çelik gövde ve şiş
- Hijyenik, emniyetli, ısıya dayanıklı cam
- Motorlu şiş döndürme mekanizması
- Tamburlu modellerde sıcak dinlendirme ünitesi

Basic Features

- Working with LPG or Natural Gas
- Gas valve with safety valve
- Radiant or pipe burner heater
- Adjustable burning capacity
- Stainless steel body and skewer
- Hygienic, safe, heat-resistant glass
- Motorized skewer mechanism
- Hot resting unit in drum rest models

Teknik Özellikler | Technical Features

Ürün Kodu Product Code	Enerji Tipi Energy Type	Gaz (Mbar) Gas (Mbar)	Güç (kW/kcal) Power (kW/kcal)	Kapasite (Şiş/Piliç) Capacity (Skewer/Chicken)	Ebat (cm) Dimensions (cm)	Ağırlık (Kg.) Weight (Kg.)	Motor Gücü (Volt/Watt) Motor Power (Volt/Watt)	Fiyat Price
PI2/M014B	🔥	21/25-30/50	8/6880	5+4/36	105X80X200	100	230 / 40	4700 €
PI5/M015B	🔥	21/25-30/50	10/8600	6+5/55	120X80X200	130	230 / 40	4900 €

Piliç Çevirme Makineleri

Chicken Rotisserie Machines

Dik Tip Piliç & Tek Vitrinli Çevirme Makineleri

Vertical Type & Single Display Chicken Grills

Gazlı

- LPG veya doğalgaz ile çalışma
- Emniyet ventilli gaz musluğu
- Paslanmaz çelik gövde ve şiş
- Boru brülörlü ısıtıcı
- Hijyenik, emniyetli, ısıya dayanıklı cam
- Motorlu şiş döndürme mekanizması

Temel Özellikler

- Monofaze veya trifaze elektrik besleme
- 2 kademeli ısınma
- Paslanmaz çelik gövde ve şiş
- Boru tipi rezistans
- Hijyenik, emniyetli, ısıya dayanıklı cam
- Motorlu şiş döndürme mekanizması

Elektrikli

Gas

- LPG or Natural gas usage
- Faucet with safety valve
- Stainless steel body and skewer
- Pipe Type burner
- Hygienic and safewith pyrex glass
- Electric motor driven skewer mechanism

Basic Features

- Single or three phase supply voltage
- Two-stage heating
- Stainless steel body and skewer
- Tube type resistances
- Hygienic and safewith pyrex glass
- Electric motor driven skewer mechanism

Electrical



PI1-M003-DG



M010-DE

Teknik Özellikler | Technical Features

Ürün Kodu Product Code	Enerji Tipi Energy Type	Gas (Mbar) Gas (Mbar)	Güç (kW/kcal) Power (kW/kcal)	Kapasite (Şiş/Piliç) Capacity (Skewer/Chicken)	Ebat (cm) Dimensions (cm)	Ağırlık (Kg.) Weight (Kg.)	Motor Gücü (Volt/Watt) Motor Power (Volt/Watt)	Fiyat Price
PI1/M003-DG	🔥	21/25-30/50	7,5/6450	3/12	89x50x76	70	230 / 22	1020 €
PI2/M004-DG	🔥	21/25-30/50	8/6880	3/15	104x50x76	74	230 / 22	1190 €
PI3/M012B	🔥	21/25-30/50	16/13760	6/24	90x60x190	128	230 / 40	2940 €
PI4/M013B	🔥	21/25-30/50	16/13760	6/30	105x60x190	168	230 / 40	3150 €
Ürün Kodu Product Code	Enerji Tipi Energy Type	Gerilim (Volt/Hz) Voltage (Volt/Hz)	Güç (kW/) Power (kW/)	Kapasite (Şiş/Piliç) Capacity (Skewer/Chicken)	Ebat (cm) Dimensions (cm)	Ağırlık (Kg.) Weight (Kg.)	Motor Gücü (Volt/Watt) Motor Power (Volt/Watt)	Fiyat Price
M003-DE	⚡	230-400 / 50-60	4,5	3/12	89x50x76	61	230 / 22	1020 €
M004-DE	⚡	230-400 / 50-60	5	3/15	104x50x76	69	230 / 22	1190 €
M010-DE	⚡	230-400 / 50-60	9	6/24	90x60x190	128	230 / 40	2940 €
M011-DE	⚡	230-400 / 50-60	10,5	6/30	105x60x190	156	230 / 40	3150 €

Kollu Piliç Makineleri

Chicken Grills Machines With Handle

Temel Özellikler

- LPG veya Doğalgaz ile çalışma
- Emniyet ventilli gaz musluğu
- Paslanmaz çelik gövde ve şiş
- Boru brülörlü ısıtıcı
- Ayarlanabilir yanma kapasitesi
- Hijyenik, emniyetli, ısıya dayanıklı cam
- Motorlu şiş döndürme mekanizması
- Şiş çıkarma kolaylığı

Basic Features

- Working with LPG or Natural Gas
- Gas valve with safety valve
- Stainless steel body and skewer
- Tubular burner heater
- Adjustable burning capacity
- Hygienic, safe, heat-resistant glass
- Motorized skewer mechanism
- Ease of skewers

**PI5/M004-K****PI6/M16-KB****Teknik Özellikler | Technical Features**

Ürün Kodu Product Code	Enerji Tipi Energy Type	Gaz (Mbar) Gas (Mbar)	Güç (kW/kcal) Power (kW/kcal)	Kapasite (Şiş/Piliç) Capacity (Skewer/Chicken)	Ebat (cm) Dimensions (cm)	Ağırlık (Kg.) Weight (Kg.)	Motor Gücü (Volt/Watt) Motor Power (Volt/Watt)	Fiyat Price
PI5/M004-K	🔥	21-25 / 30-50	10/8600	3/15	122x60x105	51	230 / 40	1360 €
PI6/M005-K	🔥	21-25 / 30-50	20/17200	4/20	122x60x115	50	230 / 40	1500 €
PI6/M16KB	🔥	21-25 / 30-50	20/17200	6/30	115x60x180	245	230 / 40	3080 €
PI6/M17KB	🔥	21-25 / 30-50	20/17200	8/40	120x60x200	320	230 / 40	3430 €

Piliç Çevirme Makineleri

Chicken Rotisserie Machines

Kömürlü Yatay Tip Piliç Çevirme

Horizontal Type Chicken Grills With Coal Fire

Kömürlü Yatay Tip Temel Özellikler

- Kömür ateşi ile pişirme
- Ateş tuğlası
- Paslanmaz çelik gövde ve şiş
- Motorlu şiş döndürme mekanizması
- Şiş kapasitesi çeşitliliği
- Kuzu çevirme mekanizması (Opsiyonel)
- Özel ölçü ve kapasitede imalat

Camlı modeller için lütfen fiyat isteyiniz

Horizontal Type With Coal Fire Basic Features

- Cooking with coal fire
- Firebricks mounted
- Stainless steel body and skewer
- Electric motor driven skewer mechanism
- Various skewer capacity
- Lamb roaster mechanism (optional)
- Manufacturing in various sizes and capacities

Please ask price for glassed model products



KM012-6

Teknik Özellikler | Technical Features

Ürün Kodu Product Code	Enerji Tipi Energy Type	Gaz (Mbar) Gas (Mbar)	Güç (kW/kcal) Power (kW/kcal)	Kapasite Capacity	Ebat (cm) Dimensions (cm)	Ağırlık (Kg.) Weight (Kg.)	Motor Gücü (Volt/Watt) Motor Power (Volt/Watt)	Fiyat Price
KM012-4		Kömürlü	-	4+4/20+20	155x105x90/70	380	230 / 40	4060 €
KM012-6		Kömürlü	-	6+6/30+30	217x105x90/70	480	230 / 40	5530 €
KM012-8		Kömürlü	-	8+8/40+40	280x105x90/70	530	230 / 40	7560 €

Gazlı Kuzu Çevirme Makineleri

Lamb Grill Machines

Gazlı Kuzu Çevirme Temel Özellikler

- LPG veya Doğalgaz ile çalışma
- Emniyet ventilli gaz musluğu
- Paslanmaz çelik gövde ve şiş
- Boru brülörlü ısıtıcı
- Ayarlanabilir yanma kapasitesi
- Hijyenik, emniyetli, ısıya dayanıklı cam
- Motorlu şiş döndürme mekanizması
- Şiş çıkarma kolaylığı

Lamb Grill Basic Features

- Working with LPG or Natural Gas
- Gas valve with safety valve
- Stainless steel body and skewer
- Tubular burner heater
- Adjustable burning capacity
- Hygienic, safe, heat-resistant glass
- Motorized skewer mechanism
- Ease of skewers



KC-M006

Ürün Kodu Product Code	Enerji Tipi Energy Type	Gaz (Mbar) Gas (Mbar)	Güç (kW/kcal) Power (kW/kcal)	Kapasite Capacity	Ebat (cm) Dimensions (cm)	Ağırlık (Kg.) Weight (Kg.)	Motor Gücü (Volt/Watt) Motor Power (Volt/Watt)	Fiyat Price
KC-M005		Gazlı	8/6880	1	115x60x90	120	230 / 40	2600 €
KC-M006		Gazlı	16/13760	2	115x60x160	194	230 / 40	3600 €
KC-M007		Gazlı	24/20640	3	115x60x190	215	230 / 40	4400 €



Kafeterya Ekipmanlari

Cafeteria Equipments

Kafeterya Ekipmanlari
Cafeteria Equipments

Kafeterya Ekipmanları

Cafeteria Equipments

Elektrikli Tost Makineleri

Electric Toasters

Temel Özellikler

- Monofaze veya trifaze besleme
- Termostat kontrollü ısıtma
- Paslanmaz çelik gövde
- Özel oluklu döküm pleyt
- Hijyenik ve emniyetli
- Uzun ömürlü
- Ergonomik tasarım

Basic Features

- Single-phase or three-phase supply
- Thermostat controlled heating
- Stainless steel body
- Special corrugated cast plate
- Hygienic and safe
- Long lasting
- Ergonomic design



M070



M071-2

Teknik Özellikler | Technical Features

Ürün Kodu Product Code	Enerji Tipi Energy Type	Gerilim (Volt/Hz) Voltage (Volt/Hz)	Güç (kW) Power (kW)	Kapasite (Dilim) Capacity (Slice)	Ebat (cm) Dimensions (cm)	Ağırlık (Kg.) Weight (Kg.)	Fiyat Price
M070	⚡	230-400 / 50-60	1,8	12	38x40x30	24	170 €
M071-1 (Blok Kapak)	⚡	230-400 / 50-60	2,2	20	54x40x30	28	240 €
M071-2 (Çift Kapak)	⚡	230-400 / 50-60	2,3	20	54x38x30	30	340 €

Ekonomik Model Fritözler

Economic Model Fryers

Eko. Fritözler Temel Özellikler

- Monofaze besleme voltajı
- Termostat kontrollü ısıtma
- Limit termostat
- Paslanmaz çelik gövde
- Paslanmaz sepet
- Hijyenik ve emniyetli
- Uzun ömürlü
- Kolay temizlenebilir yağ haznesi

Eco. Fryers Basic Features

- Single phase supply voltage
- Thermostatic controlled heating
- Limit thermostat
- Stainless steel body
- Stainless baskets
- Hygienic and safe
- Long life cycle
- Easy to clean oil container

**M056****M057****M058****M059****Teknik Özellikler | Technical Features**

Ürün Kodu Product Code	Enerji Tipi Energy Type	Gerilim (Volt/Hz) Voltage (Volt/Hz)	Güç (kW/) Power (kW/)	Kapasite (Lt.) Capacity (Lt.)	Ebat (cm) Dimensions (cm)	Ağırlık (Kg.) Weight (Kg.)	Fiyat Price
M056	⚡	230-400 / 50-60	2,25	3	18x43x33,5	7	110 €
M058	⚡	230-400 / 50-60	4,5	3+3	35x43x33,5	9	200 €
M057	⚡	230-400 / 50-60	2,25	5	27x43x33,5	8	130 €
M059	⚡	230-400 / 50-60	4,5	5+5	53x43x33,5	12	220 €
M060	⚡	230-400 / 50-60	3,5	8	32,5x45,5x33,5	13	200 €
M060-1	⚡	230-400 / 50-60	7	8+8	65x45,5x33,5	18	360 €

Kafeterya Ekipmanları

Cafeteria Equipments

Krep Makinaları

Crepe Machines

Temel Özellikler

- Teflon kaplı döküm pleytler
- Paslanmaz çelik gövde ve brülör
- Tam veya kısık yanış seçeneği
- Hijyenik ve emniyetli
- Uzun ömürlü
- LPG veya Doğalgaz ile çalışma (Gazlı)
- Monofaze veya trifaze besleme voltajı (Elektrikli)

Basic Features

- Teflon coated cast plates
- Stainless steel body and burner
- Adjustable burner capacity
- Hygienic and safe
- Long life cycle
- LPG or Natural Gas usage (Gas)
- Single or three phase supply voltage (Electric)



M097



M098

Teknik Özellikler | Technical Features

Ürün Kodu Product Code	Enerji Tipi Energy Type	Gaz (Mbar) Gas (Mbar)	Güç (kW/kcal) Power (kW/kcal)	Kapasite (Pleyt) Capacity (Pleyt)	Ebat (cm) Dimensions (cm)	Ağırlık (Kg.) Weight (Kg.)	Fiyat Price
M097-G	🔥	21/25-30/50	4	1 x Ø35cm	38x46x17	17	210 €
M098-G	🔥	21/25-30/50	4+4	2 x Ø35cm	76x46x17	30	390 €

Ürün Kodu Product Code	Enerji Tipi Energy Type	Gerilim (Volt/Hz) Voltage (Volt/Hz)	Güç (kW/) Power (kW/)	Kapasite (Pleyt) Capacity (Pleyt)	Ebat (cm) Dimensions (cm)	Ağırlık (Kg.) Weight (Kg.)	Fiyat Price
M097	⚡	220-380 / 50-60	2,2	1 x Ø35cm	38x46x15	17	210 €
M098	⚡	220-380 / 50-60	2 x 2,2	2 x Ø35cm	76x46x15	30	390 €

Bakır & Paslanmaz Izgaralar

Copper & Stainless Grills

Temel Özellikler

- Bakır işlemeli kaplama seçeneği
- Kendinden davlumbazlı
- Izgara tablalı
- Kömür izgaralı
- Ayarlanabilir ayaklı

Basic Features

- Copper coating option
- Mounted hood
- Grill plate
- Coal plate
- Adjustable rutil



MB18-A



MB17-K



MB17-2P

Teknik Özellikler | Technical Features

Ürün Kodu Product Code	Enerji Tipi Energy Type	Ebat (cm) Dimensions (cm)	Fiyat Price
MB17-A (Açık)		100x45x120	770 €
MB18-A (Açık)		120x45x120	1000 €
MB17-K (Kapalı)		150x45x120	1160 €
MB17-1 (Paslanmaz)		75x60x105	690 €
MB17-2 (Paslanmaz)		120x60x105	880 €

Kafeterya Ekipmanları

Cafeteria Equipments

Elektrikli Salamander Makinaları

Electric Salamander Grill

Temel Özellikler

- Monofaze besleme voltajı
- Termostat kontrollü ısıtma
- Boru tipi rezistans ısıtıcı
- Paslanmaz çelik gövde
- Paslanmaz tel ızgara
- Ayarlanabilir raf yüksekliği
- Hijyenik ve emniyetli
- Uzun ömürlü

Basic Features

- Single or three phase supply voltage
- Thermostatic controlled heating
- Tube type resistance heater
- Stainless steel body
- Stainless steel wire plate
- Adjustable plate height
- Hygienic and safe
- Long life cycle



M020-1

Teknik Özellikler | Technical Features

Ürün Kodu Product Code	Enerji Tipi Energy Type	Gerilim (Volt/Hz) Voltage (Volt/Hz)	Güç (kW/) Power (kW/)	Kapasite (Asansör) Capacity (Lift)	Ebat (cm) Dimensions (cm)	Ağırlık (Kg.) Weight (Kg.)	Fiyat Price
M020	⚡	220-380 / 50-60	2,5	1	45x45x50	28	900 €
M020-1	⚡	220-380 / 50-60	5	1	60x60x50	38	1100 €

Elektrikli Sandviç Isıtıcıları & Reşolar

Electrical Sandwich Warmers & Chafing Dish

Temel Özellikler

- Paslanmaz çelik gövde
- Sandviç ısıtıcılarda, cam silindir Ø200x240 mm'dir.
- Sandviç ısıtıcılarda, Sıcaklık aralığı 40°C - 100°C 'dir.
- Reşolar GN 1/1-65 mm kapasitelidir.
- Reşolar 2 adet yakıt haznelidir.

Basic Features

- Stainless steel body
- Glass cylinder Ø200x240 mm in sandwich warmers
- Temperature range 40°C - 100°C in sandwich warmers
- GN 1 / 1 -65 mm capacity in chafing dish
- 2 fuel holders in chafing dish

Çorba Isıtıcıları Temel Özellikler

- Monofaze besleme voltajı
- Termostat kontrollü ısıtma
- Paslanmaz çelik hazne
- Çorbayı istenen sıcaklıkta muhafaza
- Hijyenik ve emniyetli
- Uzun ömürlü
- Susuz çalışma koruması

Soup Warmers Basic Features

- Single phase supply voltage
- Thermostatic controlled heating
- Stainless steel container
- Keeps the soup desired temperature
- Hygienic and safe
- Long life cycle
- Protection against waterless working



R1



R2



M083



M027

Teknik Özellikler | Technical Features

Ürün Kodu Product Code	Enerji Tipi Energy Type	Ebat (cm) Dimensions (cm)	Ağırlık (Kg.) Weight (Kg.)	Fiyat Price			
R1-1		64x65x39	7	270 €			
R2-2		64x65x39	7	220 €			
Ürün Kodu Product Code	Enerji Tipi Energy Type	Gerilim (Volt/Hz) Voltage (Volt/Hz)	Güç (Watt) Power (Watt)	Kapasite Capacity	Ebat (cm) Dimensions (cm)	Ağırlık (Kg.) Weight (Kg.)	Fiyat Price
R1		-	-	-	64x65x39	8	350 €
R2		-	-	-	64x65x39	8	370 €
M083		220-380 / 50-60	0,60	3 Şiş/Skewer	50x28x40	7	520 €
M084		220-380 / 50-60	0,90	4 Şiş/Skewer	50x35x40	9	610 €
M027		230 / 50-60	1,94	9 Lt.	36x42x38	3	230 €

Kafeterya Ekipmanları

Cafeteria Equipments

Karlı İçecek Makinaları & Elektrikli Meşrubat Dispanseri

Ice Slush Machines & Electric Beverage Dispensary

Temel Özellikler

- Kırılmaya dayanıklı polikarbon hazne
- Şeffaf, sağlam ve hijyenik
- Paslanmaz çelik yan ve ön saclar
- Sessiz güçlü kompresörlü
- Ergonomik, kolay temizlenebilir

Basic Features

- Break-resistant polycarbonate
- Clear, robus and hygienic
- Stainless front and side steel
- Silent, strong compressor
- Ergonomic and easy-wash



M086



M087-E



M085-1



M085-2



M085-3

Teknik Özellikler | Technical Features

Ürün Kodu Product Code	Enerji Tipi Energy Type	Gerilim (Volt/Hz) Voltage (Volt/Hz)	Güç (kW/) Power (kW/)	Kapasite (Tank/Lt.) Capacity (Tank/Lt.)	Ağırlık (Kg.) Weight (Kg.)	Fiyat Price
M086	⚡	220 / 50-60	0,4	İkili-Double / 11	53	1750 €
M087-E	⚡	220 / 50-60	0,4	Üçlü-Triple / 30	62	2450 €
M085-1	⚡	220 / 50-60	0,55	Tekli-Single / 20	22	580 €
M085-2	⚡	220 / 50-60	0,72	İkili-Double / 20+20	30	840 €
M085-3	⚡	220 / 50-60	1,1	Üçlü-Triple / 20+20+20	40	1210 €

Meyve Sıkma Makinaları

Chafing Dish

Meyve Sıkma Makinaları Temel Özellikler

- Paslanmaz çelik AISI 304 (18/10)
- Su geçirmez motor bloğu
- Sessiz çalışma
- Hijyenik ve uzun ömürlü

Chafing Dish Basic Features

- Stainless steel AISI 304 (18/10)
- Water proof motor block
- Silent operation
- Hygienic and longevous



M087



M088



M089



M090

Teknik Özellikler | Technical Features

Ürün Kodu Product Code	Enerji Tipi Energy Type	Gerilim (Volt/Hz) Voltage (Volt/Hz)	Güç (kW/) Power (kW/)	Ağırlık (Kg.) Weight (Kg.)	Fiyat Price
M087 (Kollu)	⚡	-	MANUEL	3	70 €
M088 (Katı Meyve)	⚡	220-380 / 50-60	0,25	4	670 €
M089 (Narenciye Sıkacağı)	⚡	220-380 / 50-60	2,5	5	230 €
M090 (Portakal Sıkacağı)	⚡	220-380 / 50-60	0,25	26	2310 €

Kafeterya Ekipmanları

Cafeteria Equipments

Gazlı Çay Kazanları

Gas Feed -Tea Boilers

Temel Özellikler

- Paslanmaz çelik kazan AISI 304 (18/10)
- Tekli, ikili, üçlü demlik seçeneği
- Kahve pişirme ocaklı
- Su doldurma ve tahliye musluklu
- Su ve ısı göstergeli
- Emniyet ventilli gaz musluğu
- Hijyenik, emniyetli ve uzun ömürlü

Basic Features

- Stainless steel boiler AISI 304 (18/10)
- Single, double or triple teapot options
- Coffee cooking stove
- Water filling and drain tap
- Water and heat indicators
- Gas valve with safety valve
- Hygienic, safe and long-lasting



M026-B3



M022-2



M022-L3

Teknik Özellikler | Technical Features

Ürün Kodu Product Code	Enerji Tipi Energy Type	Gerilim (Volt/Hz) Voltage (Volt/Hz)	Güç (kW) Power (kW)	Kapasite (Demlik / Lt.) Capacity (Tea Pot / Lt.)	Ebat (cm) Dimensions (cm)	Fiyat Price
M022-1 (Ekonomik)	🔥	230 / 50-60	3,8	1 / 13	48x24x38	170 €
M022-2 (Ekonomik)	🔥	230 / 50-60	4,4	2 / 23	60x28x42	300 €
M022-3 (Ekonomik)	🔥	230 / 50-60	4,4	3 / 39	75x40x45	330 €
M022-L2 (Lüks)	🔥	230 / 50-60	4,4	2 / 23	60x28x42	930 €
M022-L3 (Lüks)	🔥	230 / 50-60	4,4	3 / 39	70x40x45	980 €
M022-L4 (Lüks)	🔥	230 / 50-60	4,4	4 / 49	90x45x50	1050 €
M026-B2 (Bakır)	🔥	230 / 50-60	4,4	2 / 23	60x28x42	1020 €
M026-B3 (Bakır)	🔥	230 / 50-60	4,4	3 / 39	75x40x45	1100 €

Elektrikli Çay Otomatları

Electrical Tea Machines

Temel Özellikler

- Paslanmaz çelik kazan AISI 304 (18/10)
- Gövde ve süzgeci paslanmaz
- Toplu tüketim için uygundur
- Hijyenik ve uzun ömürlüdür
- Otomatik ısı kontrol sistemi, tasarruflu

Basic Features

- Stainless steel boiler AISI 304 (18/10)
- Body and strainer are stainless
- Suitable for mass consumption
- Hygienic and long lasting
- Automatic heat control system, economical



M026-80



M026-120

Teknik Özellikler | Technical Features

Ürün Kodu Product Code	Enerji Tipi Energy Type	Gerilim (Volt/Hz) Voltage (Volt/Hz)	Güç (kW/) Power (kW/)	Kapasite (Bardak/Lt.) Capacity (Glass/Lt.)	Ağırlık (Kg.) Weight (Kg.)	Fiyat Price
M026-40	⚡	230 / 50-60	0,9	40 / 5	3,5	80 €
M026-60	⚡	230 / 50-60	1,2	60 / 7	4	90 €
M026-80	⚡	230 / 50-60	1,4	80 / 9	4,5	110 €
M026-120	⚡	230 / 50-60	1,75	120 / 13	5	120 €
M026-160	⚡	230 / 50-60	1,75	160 / 15	5,5	130 €
M026-250	⚡	230 / 50-60	2,15	250 / 22	6,3	150 €

Kafeterya Ekipmanları

Cafeteria Equipments

Espresso & Filtre Kahve Makinesi

Espresso & Drip Pot Machines

Espresso Makinesi Temel Özellikler

- Otomatik kazan dolum
- Manuel kahve dozajlama
- Otomatik kahve grubu ters yıkama
- Su yokluğunda rezistans koruma
- Bir buhar ve Bir Sıcak Su Musluklu

Espresso Machines Basic Features

- Automatic boiler filling
- Manual coffee dosing
- Automatic coffee group backwash
- Resistance protection in the absence of water
- One steam and one hot water tap

Filtre Kahve Makinesi Temel Özellikler

- Susuz kaynama koruması
- Hızlı demleme süresi (6 dakika)
- Kapasite: 144 fincan/saat
- 2 x 1.8 lt. cam pot kapasitesi

Drip Pot Machines Basic Features

- Anhydrous boiling protection
- Fast brewing time (6 minutes)
- Capacity: 144 cups / hour
- 2 x 1.8 lt. glass pot capacity



Teknik Özellikler | Technical Features

Ürün Kodu Product Code	Enerji Tipi Energy Type	Gerilim (Volt/Hz) Voltage (Volt/Hz)	Güç (kW/) Power (kW/)	Ebat (cm) Dimensions (cm)	Kapasite Capacity	Ağırlık (Kg.) Weight (Kg.)	Fiyat Price
BRV1G	⚡	220 / 50-60	1,55	52x52x54	6,5 Lt. Boiler+0,60 Lt.	36	1900 €
BRV2G	⚡	220 / 50-60	2,65	69x52x54	13 Lt. Boiler+ 2x1,5 Lt.	64	2990 €
FLT120	⚡	220 / 50-60	2,4	19x37x44	1.8 lt.	6	350 €

Bar Blender & Kahve Değirmeni

Pub Blender & Coffee Mill

Bar Blender Temel Özellikler

- Değişken hız kontrolü
- Çok fonksiyonlu
- Islak ve kuru uygulama
- İki bir arada paslanmaz çelik kesme bıçağı
- Üstün kalite, şeffaf konteyner

Bar Blender Basic Features

- Variable speed control
- Multifunctional
- Wet and dry application
- Two-in-one stainless steel cutting blade
- Superior quality, transparent container

Kahve Değirmeni Temel Özellikler

- 30 dk durmadan çalışabilme özelliği
- 5-12 gr dozaj ayarı
- 0-500 gr kahveyi 6 dk da öğütebilir
- Çekilmiş kahve kapasitesi: 300 gr
- Hazne kapasitesi: 0,5 kg.
- Devir hızı: 1300 - 1600 rpm

Coffee Mill Basic Features

- Ability to work without stopping for 30 minutes
- 5-12 gr dosage setting
- It can grind 0-500 gr coffee in 6 minutes
- Ground coffee capacity: 300 gr
- Hopper capacity: 0.5 kg.
- Speed of rotation: 1300 - 1600 rpm

**BBL****KHD CUNILL****PMKM-5****Teknik Özellikler | Technical Features**

Ürün Kodu Product Code	Enerji Tipi Energy Type	Gerilim (Volt/Hz) Voltage (Volt/Hz)	Güç (kW/) Power (kW/)	Ebat (cm) Dimensions (cm)	Kapasite Capacity	Ağırlık (Kg.) Weight (Kg.)	Fiyat Price
BBL	⚡	220 / 50-60	1,2	20,5 x 23 x 51	2 Lt.	4,3	350 €
KHD CUNILL	⚡	220 / 50-60	0,27	17 x 34 x 41	0,3 Kg.	6	480 €
PMKM-5	⚡	220-240 / 50-60	0,6-1	45 x 30 x 42	5 Lt.	6,5	380 €
PMKM-8	⚡	220-240 / 50-60	0,6-1	50 x 31 x 43,5	8 Lt.	7,5	470 €



Hazırlık Ekipmanları
Preparation Equipments

BOGAZICI

Hazırlık Ekipmanları

Preparation Equipments





**Kalite &
Uygun Fiyat**
Quality, Competitive Price...

BOĞAZICI

Kurulduğumuz 2003 yılından beri Kaizen anlayışını benimsemiş olmamız “Boğaziçi Makina”yı hazırlık ekipmanları alanında kalite sembolü haline getirmiştir. Böylelikle Boğaziçi Makina sektöre yön veren ve rakipleri tarafından takip edilen bir pozisyona oturmuştur.

Modern tasarımlarımızı 4.000 metrekarelik kapalı alana sahip fabrikamızda teknolojinin tüm imkanlarını kullanarak üretiyoruz...

Nitelikli personelimiz ve esnek çalışma prensibimiz ile müşteri memnuniyetini önceliyoruz...

Ürünlerimiz ile 100'e yakın ülkede hizmet veriyor olmamız ise en büyük mutluluk ve motivasyon kaynağımız...

Since our establishment in 2003, we have adopted the Kaizen approach and made “Boğaziçi Machinery” a symbol of quality in the field of preparation equipment. Thus, Boğaziçi Machinery have a position that directs the sector and is followed by its competitors...

We produce our modern designs in our factory which has a closed area of 4,000 square meters by using all benefits of technology...

We prioritize customer satisfaction with our qualified staff and flexible working principles ...

Our biggest source of happiness and motivation is that we serve in nearly 100 countries with our products...



Ekonomik Kıyma Makineleri

Eco Model Meat Mincing Machines

Temel Özellikler

- Paslanmaz çelik malzemeden dış gövde ve tepsi
- Kolay temizlenebilir tasarım
- Sökülebilir bilezik, ayna, bıçak ve helezon

Basic Features

- Stainless steel outer body and tray
- Easy to clean design
- Demountable nut, plate, blade and screw

**BKM.22E ECO****BKM.32E ECO****Teknik Özellikler | Technical Features**

Ürün Kodu Product Code	Kapasite (Kg/Saat) Capacity (Kg/h)	Voltaj (Volt/Hz) Voltage (Volt/Hz)	Güç (kW/hp) Power (kW/hp)	Ağırlık (Kg.) Weight (Kg.)	Ebat (mm) Dimensions (mm)	Fiyat Price
BKM.22E ECO	200	220-380 / 50-60	1,1 / 1,5	38	760x290x320	700 €
BKM.32E ECO	300	220-380 / 50-60	1,1 / 1,5	43	760x290x320	740 €

Kıyma Makineleri

Meat Mincing Machines

Temel Özellikler

- Paslanmaz çelik malzemeden dış gövde ve tepsi
- Kolay temizlenebilir tasarım
- Sökülebilir bilezik, ayna, bıçak ve helezon

Basic Features

- Stainless steel outer body and tray
- Easy to clean design
- Demountable nut, plate, blade and screw



BKM.12

BKM.22

BKM.32

Teknik Özellikler | Technical Features

Ürün Kodu Product Code	Kapasite (Kg/Saat) Capacity (Kg/h)	Voltaj (Volt/Hz) Voltage (Volt/Hz)	Güç (kW/hp) Power (kW/hp)	Ağırlık (Kg.) Weight (Kg.)	Ebat (mm) Dimensions (mm)	Fiyat Price
BKM.12	100	220/ 50-60	0,55 / 0,7	25	540x260x310	480 €
BKM.22	400	220-380 / 50-60	1,5 / 2	52	770x310x350	770 €
BKM.32	600	220-380 / 50-60	2,2-3 / 2,9-4	65	870x330x400	910 €

Soğutuculu Kıyma Makineleri

Meat Mincing Machines with Coller

Temel Özellikler

- Paslanmaz çelik malzemeden dış gövde ve tepsi
 - Kolay temizlenebilir tasarım
- Sökülebilir bilezik, ayna, bıçak ve helezon
- Dijital göstergeli soğutma sistemi

Basic Features

- Outer body and tray made of stainless steel
- Easy to clean design
- Demountable nut, plate, blade and screw
- Cooling system with digital display

**BKM.22S****BKM.32S****Teknik Özellikler | Technical Features**

Ürün Kodu Product Code	Kapasite (Kg/Saat) Capacity (Kg/h)	Voltaj (Volt/Hz) Voltage (Volt/Hz)	Güç (kW/hp) Power (kW/hp)	Ağırlık (Kg.) Weight (Kg.)	Ebat (mm) Dimensions (mm)	Fiyat Price
BKM.22S	400	220-380 / 50-60	1,5 / 2	67	860x360x430	1190 €
BKM.32S	600	220-380 / 50-60	2,2-3 / 3-4	80	860x360x460	1360 €

Paslanmaz Kıyma Makineleri

Stainless Steel Meat Mincing Machines

Temel Özellikler

- Tamamen paslanmaz çelik
- Kolay temizlenebilir tasarım
- Sökülebilir bilezik, ayna, bıçak ve helezon

Basic Features

- Completely stainless steel
- Easy to clean design
- Demountable nut, plate, blade and screw



BPKM.22

BPKM.32

BPKM.32M

Çıkma Kafa Ünitesi



Removable Head Unit

Teknik Özellikler | Technical Features

Ürün Kodu Product Code	Kapasite (Kg/Saat) Capacity (Kg/h)	Voltaj (Volt/Hz) Voltage (Volt/Hz)	Güç (kW/hp) Power (kW/hp)	Ağırlık (Kg.) Weight (Kg.)	Ebat (mm) Dimensions (mm)	Fiyat Price
BPKM.22	400	220-380 / 50-60	1,5 / 2	55	770x310x350	1120 €
BPKM.32	600	220-380 / 50-60	2,2-3 / 2,9-4	68	870x330x400	1230 €
BPKM.32M	300	220-380 / 50-60	1,5 / 2	47	630x250x400	1230 €

Paslanmaz Soğutuculu Kıyma Makineleri

Stainless Steel Meat Mincing Machines With Cooler

Temel Özellikler

- Tamamen paslanmaz çelik
- Kolay temizlenebilir tasarım
- Sökülebilir bilezik, ayna, bıçak ve helezon
- Dijital göstergeli soğutma sistemi

Basic Features

- Completely stainless steel
- Easy to clean design
- Demountable nut, plate, blade and screw
- Cooling system with digital display

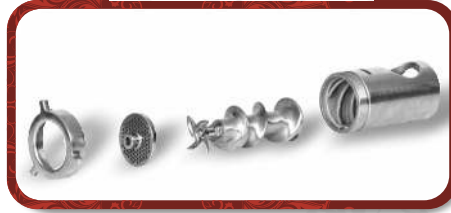
**BPKM.22S****BPKM.32S****BPKM.32MS****Çıkma Kafa Ünitesi****Removable Head Unit****Teknik Özellikler | Technical Features**

Ürün Kodu Product Code	Kapasite (Kg/Saat) Capacity (Kg/h)	Voltaj (Volt/Hz) Voltage (Volt/Hz)	Güç (kW/hp) Power (kW/hp)	Ağırlık (Kg.) Weight (Kg.)	Ebat (mm) Dimensions (mm)	Fiyat Price
BPKM.22S	400	220-380 / 50-60	1,5 / 2	70	770x310x350	1470 €
BPKM.32S	600	220-380 / 50-60	2,2-3 / 3-4	87	870x330x400	1580 €
BPKM.32MS	300	220-380 / 50-60	1,5 / 2	57	680x290x510	1580 €

Paslanmaz Kıyma Makineleri

Stainless Steel Meat Mincing Machines

Temel Özellikler

- Tamamen paslanmaz çelik
- Kolay temizlenebilir tasarım
- Sökülebilir bilezik, ayna, bıçak ve helezon
- Sinir ayıklama aparatı seçeneği*

Basic Features

- Completely stainless steel
- Easy to clean design
- Demountable nut, plate, blade and screw
- Unger system option*



BPKM.42A



BPKM.130

Sinir Ayıklama Aparatı



Unger System

Teknik Özellikler | Technical Features

Ürün Kodu Product Code	Kapasite (Kg/Saat) Capacity (Kg/h)	Voltaj (Volt/Hz) Voltage (Volt/Hz)	Güç (kW/hp) Power (kW/hp)	Ağırlık (Kg.) Weight (Kg.)	Ebat (mm) Dimensions (mm)	Fiyat Price
BPKM.42	800	380 / 50-60	5,5 / 7,4	140	960x470x480	3150 €
BPKM.42A	800	380 / 50-60	5,5 / 7,4	155	1000x540x930	3300 €
BPKM.130	1500	380 / 50-60	11 / 14,7	300	1400x720x1290	6650 €

*Sinir Ayıklama Aparatı +1000€
Unger system +1000€*

Paslanmaz Soğutuculu Kıyma Makineleri

Stainless Steel Meat Mincing Machines with Cooler

Temel Özellikler

- Tamamen paslanmaz çelik
- Kolay temizlenebilir tasarım
- Sökülebilir bilezik, ayna, bıçak ve helezon
- Dijital göstergeli soğutma sistemi
- Sinir ayıklama aparatı seçeneği*

Basic Features

- Completely stainless steel
- Easy to clean design
- Demountable nut, plate, blade and screw
- Cooling system with digital display
- Unger system option



BPKM.42S.A



BPKM.130S

Sinir Ayıklama Aparatı



Unger System

Teknik Özellikler | Technical Features

Ürün Kodu Product Code	Kapasite (Kg/Saat) Capacity (Kg/h)	Voltaj (Volt/Hz) Voltage (Volt/Hz)	Güç (kW/hp) Power (kW/hp)	Ağırlık (Kg.) Weight (Kg.)	Ebat (mm) Dimensions (mm)	Fiyat Price
BPKM.42S	800	380 / 50-60	5,5 / 7,4	155	950x470x480	3420 €
BPKM.42S.A	800	380 / 50-60	5,5 / 7,4	170	1000x540x930	3580 €
BPKM.130S	1500	380 / 50-60	11 / 14,7	315	1400x720x1290	7700 €

Sinir Ayıklama Aparatı +1000€
Unger system +1000€

Paslanmaz Çıkma Kafa Kıyma Makineleri

Stainless Steel Meat Mincing Machines With Removable Head Unit

Temel Özellikler

- Tamamen paslanmaz çelik
- Kolay temizlenebilir tasarım
- Sökülebilir bilezik, ayna, bıçak, helezon ve kovan

Basic Features

- Completely stainless steel
- Easy to clean design
- Demountable nut, plate, blade and screw

Yeni Ürünler

New Products



BPKM.12M



BPKM.32C

Çıkma Kafa Ünitesi



Removable Head Unit

Compact Model Çıkma Kafa Ünitesi



Removable Head Unit for Compact Model

Teknik Özellikler | Technical Features

Ürün Kodu Product Code	Kapasite (Kg/Saat) Capacity (Kg/h)	Voltaj (Volt/Hz) Voltage (Volt/Hz)	Güç (kW/hp) Power (kW/hp)	Ağırlık (Kg.) Weight (Kg.)	Ebat (mm) Dimensions (mm)	Fiyat Price
BPKM.12M	100	220/ 50-60	0,55 / 0,7	29	500x250x400	690 €
BPKM.32C	300	220-380 / 50-60	1,5 / 2	36	570x350x280	900 €

Et Parçalama Makineleri

Meat Cutting Machine

Temel Özellikler

- Tamamen paslanmaz çelik
- Kolay temizlenebilir tasarım
- Sökülebilir tencere ve bıçak
 - Dijital ekran seçeneği
- Humus yapabilme kabiliyeti

Basic Features

- All stainless steel
- Easy to clean design
- Detachable pot and knife
- Digital display option
- Ability to make humus

**BSZK.2****BSZK.8****BZK****Teknik Özellikler | Technical Features**

Ürün Kodu Product Code	Kapasite (Kg) Capacity (Kg)	Voltaj (Volt/Hz) Voltage (Volt/Hz)	Güç (kW/hp) Power (kW/hp)	Ağırlık (Kg.) Weight (Kg.)	Ebat (mm) Dimensions (mm)	Fiyat Price
BSZK.2	2	220-380 / 50-60	0,55 / 0,7	20	540x350x390	610 €
BSZK.8	8	220-380 / 50-60	3 / 4	50	700x470x520	1200 €
BZK	8	220-380 / 50-60	2,2-3 / 3-4	42	650x440x870	1300 €

Paslanmaz Kemik Testeresi & Tavuk Kesme Makineleri

Stainless Steel Bone Saw & Chicken Cutting Machines

Temel Özellikler

- Tamamen paslanmaz çelik
- Kolay temizlenebilir tasarım
- Kemik Testerelerinde ayarlanabilir şerit gerginliği
- Kemik Testerelerinde Frenli motor

Basic Features

- Completely stainless steel
- Easy to clean design
- Adjustable saw tension
- Brake motor



BKT



BTK

Güvenli & Kolay Kesim

Secure & Easy Cut

Teknik Özellikler | Technical Features

Ürün Kodu Product Code	Kapasite(mm) Capacity (mm)	Kapasite(Adet/Saat) Capacity (Pcs/h)	Voltaj (Volt/Hz) Voltage (Volt/Hz)	Güç (kW/hp) Power (kW/hp)	Ağırlık (Kg.) Weight (Kg.)	Ebat (mm) Dimensions (mm)	Fiyat Price
BKT	300	–	220-380 / 50-60	1,1 / 1,5	70	480x680x1600	1480 €
BKTA	300	–	220-380 / 50-60	1,1 / 1,5	80	650x600x990	1620 €
BTK	–	100	220-380 / 50-60	0,55 / 0,7	28	490x400x425	840 €

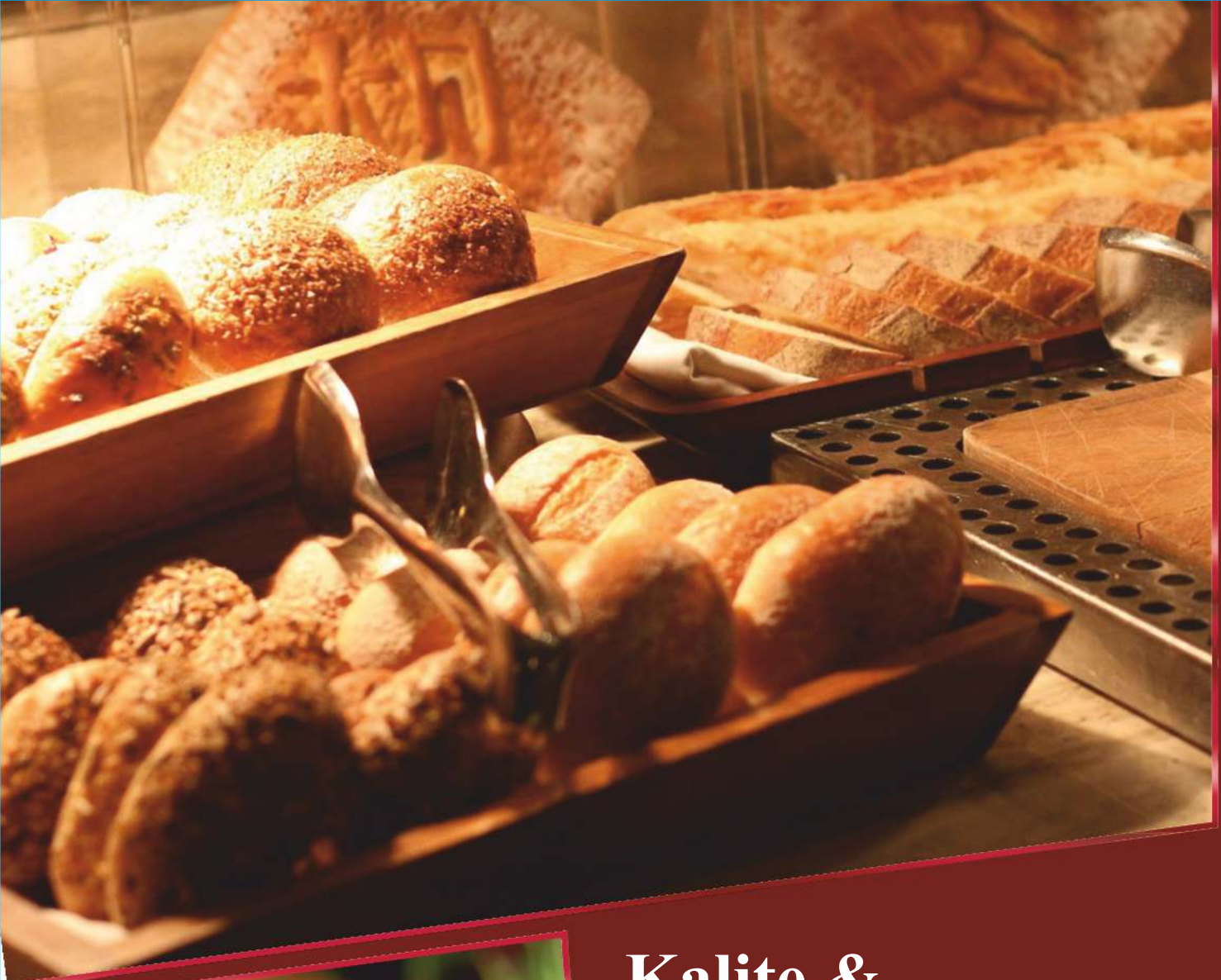

**Kalite &
Uygun Fiyat**
Quality, Competitive Price...



Hamur Yoğurma Makineleri

Dough Kneading Machines

Temel Özellikler

- Paslanmaz çelik kazan ve çatal
- İsteğe bağlı çiğköfte karıştırma aparat seçeneği
- Güçlü Gövde Tasarımı

Basic Features

- Stainless steel bowl and fork
- Optional raw Cig Kofte option
- Strong Body Design



BHY.5



BHY.35



BHY.235

Teknik Özellikler | Technical Features

Ürün Kodu Product Code	Kapasite (Un/Hamur Kg) Capacity (Flour/Dough Kg)	Voltaj (Volt/Hz) Voltage (Volt/Hz)	Güç (kW/hp) Power (kW/hp)	Ağırlık (Kg.) Weight (Kg.)	Ebat (mm) Dimensions (mm)	Fiyat Price
BHY.5	3 / 5	220-380 / 50-60	0,25 / 0,3	25	610x315x500	490 €
BHY.10	7 / 10	220-380 / 50-60	0,37 / 0,5	60	700x460x600	550 €
BHY.25	10 / 25	220-380 / 50-60	0,55 / 0,7	68	750x500x640	670 €
BHY.35	25 / 35	220-380 / 50-60	0,55 / 0,7	95	840x550x750	770 €
BHY.50	35 / 50	220-380 / 50-60	0,55 / 0,7	115	970x650x770	880 €
BHY.75	50 / 75	220-380 / 50-60	1,1 / 1,5	200	1120x820x730	1360 €
BHY.100	75 / 100	220-380 / 50-60	1,5 / 2,0	220	1280x930x1070	1960 €
BHY.135	100 / 135	220-380 / 50-60	1,5 / 2,0	235	1300x950x1070	2240 €
BHY.235	150 / 235	380 / 50-60	3 / 4,0	415	1600x1100x1200	5000 €

Kapaklı Hamur Yoğurma Makineleri

Dough Kneading Machines With Cover

Temel Özellikler

- Paslanmaz çelik kazan ve çatal
- İsteğe bağlı çiğköfte karıştırma aparat seçeneği
 - Şeffaf kazan kapağı
 - Güçlü gövde tasarımı

Basic Features

- Stainless steel bowl and fork
- Optional raw Cig Kofte option
- Transparent boiler cover
- Strong body design



BHY.135K



BHY.235K

Teknik Özellikler | Technical Features

Ürün Kodu Product Code	Kapasite (Un/Hamur Kg) Capacity (Flour/Dough Kg)	Voltaj (Volt/Hz) Voltage (Volt/Hz)	Güç (kW/hp) Power (kW/hp)	Ağırlık (Kg.) Weight (Kg.)	Ebat (mm) Dimensions (mm)	Fiyat Price
BHY.10K	7 / 10	220-380 / 50-60	0,37 / 0,5	65	700x460x600	660 €
BHY.25K	10 / 25	220-380 / 50-60	0,55 / 0,7	73	750x500x640	810 €
BHY.35K	25 / 35	220-380 / 50-60	0,55 / 0,7	100	840x550x750	900 €
BHY.50K	35 / 50	220-380 / 50-60	0,55 / 0,7	120	970x650x770	1050 €
BHY.75K	50 / 75	220-380 / 50-60	1,1 / 1,5	205	1120x820x730	1580 €
BHY.100K	75 / 100	220-380 / 50-60	1,5 / 2,0	225	1280x930x1070	2200 €
BHY.135K	100 / 135	220-380 / 50-60	1,5 / 2,0	245	1300x950x1070	2490 €
BHY.235K	150 / 235	380 / 50-60	3 / 4,0	425	1600x1100x1200	5950 €

Spiral Hamur Yoğurma Makineleri

Spiral Dough Kneading Machines

Temel Özellikler

- Paslanmaz çelik kazan ve spiral burgu
 - Çift devirli zaman ayarı
 - İki yöne hareketli kazan
 - Şeffaf kazan kapağı
 - Dijital ekran seçeneği

Basic Features

- Stainless steel boiler and spiral auger
- Double speed timer
- Moving boiler on two direction
- Transparent boiler cover
- Digital display option



BSH.35



BSH.135

Teknik Özellikler | Technical Features

Ürün Kodu Product Code	Kapasite (Un/Hamur Kg) Capacity (Flour/Dough Kg)	Voltaj (Volt/Hz) Voltage (Volt/Hz)	Güç (kW/hp) Power (kW/hp)	Ağırlık (Kg.) Weight (Kg.)	Ebat (mm) Dimensions (mm)	Fiyat Price
BSH.10	7 / 10	380 / 50-60	0,37 / 0,5	50	710x360x630	1120 €
BSH.20	10 / 20	380 / 50-60	0,55 / 0,7	70	740x430x630	1260 €
BSH.35	25 / 35	380 / 50-60	1,5-2,5 / 2-3,4	255	1070x550x1060	3000 €
BSH.50	35 / 50	380 / 50-60	1,5-2,5 / 2-3,4	260	1150x600x1060	3220 €
BSH.75	50 / 75	380 / 50-60	3,5-5,5 / 4,7-7,4	320	1200x700x1300	5900 €
BSH.135	100 / 135	380 / 50-60	5,5-7,5 / 7,4-10,1	400	1600x900x1570	8400 €
BSH.235	150 / 235	380 / 50-60	5,5-7,5 / 7,4-10,1	420	1700x1000x1570	9100 €

Mikser Makineleri

Mixer Machines

Temel Özellikler

- Paslanmaz çelik kazan
- Kolay temizlenebilir tasarım
- Paslanmaz çelik malzemeden karıştırıcı spiral, palet ve çırpıcı
- Şeffaf kazan kapağı
- Dijital ekran seçeneği

Basic Features

- Stainless steel bowl
- Easy to clean design
- Mixer spiral, pallet and whisk made of stainless steel material
- Transparent boiler cover
- Digital display option



BM.10S



BM.40S



BM.60

Teknik Özellikler | Technical Features

Ürün Kodu Product Code	Kapasite (lt.) Capacity (lt.)	Voltaj (Volt/Hz) Voltage (Volt/Hz)	Güç (kW/hp) Power (kW/hp)	Ağırlık (Kg.) Weight (Kg.)	Ebat (mm) Dimensions (mm)	Fiyat Price
BM.10S	10	220-380 / 50-60	0,55 / 0,7	54	540x415x660	1120 €
BM.20S	20	220-380 / 50-60	0,6-0,9 / 0,8-1,2	94	740x470x830	1370 €
BM.40S	40	220-380 / 50-60	1-1,7 / 1,3-2,3	155	840x600x1050	2170 €
BM.60S	60	220-380 / 50-60	1-1,7 / 1,3-2,3	160	840x630x1050	2380 €
BM.60	60	220-380 / 50-60	1-1,7 / 1,3-2,3	300	730x630x1220	3000 €

Boyalı Hamur Açma Makineleri

Painted Dough Rollers Machines



BHA.40TB



BHA.40B

Teknik Özellikler | Technical Features

Ürün Kodu Product Code	Kapasite (cm) Capacity (cm)	Merdane Roller	Voltaj (Volt/Hz) Voltage (Volt/Hz)	Güç (kW/hp) Power (kW/hp)	Ağırlık (Kg.) Weight (Kg.)	Ebat (mm) Dimensions (mm)	Fiyat Price
BHA.30B	30	2'li	220-380 / 50-60	0,25 / 0,3	40	450x420x580	700 €
BHA.30TB	30	1'li	220-380 / 50-60	0,25 / 0,3	28	430x420x400	525 €
BHA.40B	40	2'li	220-380 / 50-60	0,25 / 0,3	45	540x450x640	840 €
BHA.40TB	40	1'li	220-380 / 50-60	0,25 / 0,3	30	520x430x400	595 €

Temel Özellikler

- Tamamen paslanmaz çelik (Opsiyonel)
 - Merdane kalınlık ayarı
 - Kolay temizlenebilir tasarım
- Tek ve çift merdane seçenekleri

Basic Features

- All stainless steel
- Roller thickness adjustment
- Easy to clean design
- Single and double roller options

Paslanmaz Hamur Açma Makineleri

Stainless Steel Dough Rollers Machines



BHA.40T



BHA.40

Teknik Özellikler | Technical Features

Ürün Kodu Product Code	Kapasite (cm) Capacity (cm)	Merdane Roller	Voltaj (Volt/Hz) Voltage (Volt/Hz)	Güç (kW/hp) Power (kW/hp)	Ağırlık (Kg.) Weight (Kg.)	Ebat (mm) Dimensions (mm)	Fiyat Price
BHA.30	30	2'li	220-380 / 50-60	0,25 / 0,3	40	450x420x580	770 €
BHA.30T	30	1'li	220-380 / 50-60	0,25 / 0,3	28	430x420x400	595 €
BHA.40	40	2'li	220-380 / 50-60	0,25 / 0,3	45	540x450x640	910 €
BHA.40T	40	1'li	220-380 / 50-60	0,25 / 0,3	30	520x430x400	665 €

Konveyörlü Hamur Açma Makinesi

Dough Roller Machines with Conveyor

Temel Özellikler

- Tamamen paslanmaz çelik
- Merdane kalınlık ayarı
- Kolay temizlenebilir tasarım

Basic Features

- All stainless steel
- Roller thickness adjustment
- Easy to clean design

**BHA.50Y****Teknik Özellikler | Technical Features**

Ürün Kodu Product Code	Kapasite (Cm) Capacity (Cm)	Merdane Roller	Voltaj (Volt/Hz) Voltage (Volt/Hz)	Güç (kW/hp) Power (kW/hp)	Ağırlık (Kg.) Weight (Kg.)	Ebat (mm) Dimensions (mm)	Fiyat Price
BHA.50Y	50	50	220 / 50-60	0,25 / 0,3	70	1525x730x1000	3300 €

Hamur Kestart Makineleri

Dough Cutting And Weighing Machines

Temel Özellikler

- Tamamen paslanmaz çelik
- Kolay temizlenebilir tasarım
- Ayarlanabilir hamur ağırlığı
- 3 Farklı Kalıp Seçeneği

Basic Features

- All stainless steel
- Easy to clean design
- Dough weight adjustment
- 3 Different mold option



BHKT.200



BHKT.200A

Teknik Özellikler | Technical Features

Ürün Kodu Product Code	Kapasite (Gr.) Capacity (Gr.)	Voltaj (Volt/Hz) Voltage (Volt/Hz)	Güç (kW/hp) Power (kW/hp)	Ağırlık (Kg.) Weight (Kg.)	Ebat (mm) Dimensions (mm)	Fiyat Price
BHKT.200	20-300	220-380 / 50-60	1,1 / 1,5	75	770x570x740	3200 €
BHKT.200A	20-300	220-380 / 50-60	1,1 / 1,5	82	770x570x1150	3360 €

Ekmek Dilimleme Makineleri

Bread Slicing Machines

Temel Özellikler

- Kolay temizlenebilir tasarım
- Paslanmaz çelik hazne ve kesici

Basic Features

- Easy to clean design
- Stainless steel chamber and cutter

**BED.T****Teknik Özellikler | Technical Features**

Ürün Kodu Product Code	Kapasite (mm) Capacity (mm)	Voltaj (Volt/Hz) Voltage (Volt/Hz)	Güç (kW/hp) Power (kW/hp)	Ağırlık (Kg.) Weight (Kg.)	Ebat (mm) Dimensions (mm)	Fiyat Price
BED	16	220 / 50-60	0,25 / 0,3	90	680x730x1050	1050 €
BED.T	20	220 / 50-60	0,25 / 0,3	90	680x730x1050	1190 €

Patates Soyma Makineleri

Potato Peeling Machines

Temel Özellikler

- Tamamen paslanmaz çelik
- Kolay temizlenebilir tasarım
 - Zaman ayarı
- Gıda uyumlu malzemeden zımpara
 - Dijital ekran seçeneği

Basic Features

- Completely stainless steel
- Easy to clean design
- Timer
- Compatible with food material
- Digital display option



BPS.25



BPS.50

Teknik Özellikler | Technical Features

Ürün Kodu Product Code	Kapasite (Kg.) Capacity (Kg.)	Voltaj (Volt/Hz) Voltage (Volt/Hz)	Güç (kW/hp) Power (kW/hp)	Ağırlık (Kg.) Weight (Kg.)	Ebat (mm) Dimensions (mm)	Fiyat Price
BPS.10	10	220-380 / 50-60	0,55 / 0,7	46	750x430x870	980 €
BPS.25	25	220-380 / 50-60	1,10 / 1,5	72	820x520x990	1330 €
BPS.35	35	220-380 / 50-60	1,50 / 2,0	75	820x520x1080	1540 €
BPS.50	50	380 / 50-60	2,20 / 2,9	100	960x630x1060	3150 €

Sebze Doğrama Makineleri

Vegetable Slicing Machines

Temel Özellikler

- Tamamen paslanmaz çelik
- Kolay temizlenebilir tasarım
 - 2 farklı besleme haznesi
 - İsteğe bağlı kübik bıçaklar

Basic Features

- All stainless steel
- Easy to clean design
 - 2 different feeding chambers
 - Optional cubic blades

- Parmak Patates Bıçak** | Finger Fries Slicer
İnce Rende | Slim Grater
Kalın Rende | Thick Grater
6mm Düz Bıçak | 6mm Flat Slicer
8mm Düz Bıçak | 8mm Flat Slicer
10mm Düz Bıçak | 10mm Flat Slicer
Yarım Ay Bıçak | Half-Moon Slicer



Teknik Özellikler | Technical Features

Ürün Kodu Product Code	Kapasite (Kg/Saat) Capacity (Kg/h)	Voltaj (Volt/Hz) Voltage (Volt/Hz)	Güç (kW/hp) Power (kW/hp)	Ağırlık (Kg.) Weight (Kg.)	Ebat (mm) Dimensions (mm)	Fiyat Price
BSU	300	220-380 / 50-60	0,25 / 0,3	25	740x410x510	700 €
BSA	300	220-380 / 50-60	0,25 / 0,3	30	790x530x920	770 €

10x10 mm Kübik Bıçak | Cubic Slicer **60€**
20x20 mm Kübik Bıçak | Cubic Slicer **60€**

Soğan Doğrama Makineleri

Onion Chopping Machines

Temel Özellikler

- Tamamen paslanmaz çelik
- Kolay temizlenebilir tasarım
- Sökülebilir tencere ve bıçak

Basic Features

- All stainless steel
- Easy to clean design
- Detachable pot and knife



BSD.E



BSD

Teknik Özellikler | Technical Features

Ürün Kodu Product Code	Kapasite (Kg) Capacity (Kg)	Voltaj (Volt/Hz) Voltage (Volt/Hz)	Güç (kW/hp) Power (kW/hp)	Ağırlık (Kg.) Weight (Kg.)	Ebat (mm) Dimensions (mm)	Fiyat Price
BSD.E	2	220-380 / 50-60	0,37 / 0,5	18	540x350x340	290 €
BSD	2	220-380 / 50-60	0,37 / 0,5	18	540x350x340	330 €

Öğütücü Makineleri

Grinder Machines

Temel Özellikler

- Paslanmaz çelik tencere ve bıçaklar
- Kolay temizlenebilir tasarım

Basic Features

- Stainless steel pots and knives
- Easy to clean design



BGO

Teknik Özellikler | Technical Features

Ürün Kodu Product Code	Kapasite (Kg) Capacity (Kg)	Voltaj (Volt/Hz) Voltage (Volt/Hz)	Güç (kW/hp) Power (kW/hp)	Ağırlık (Kg.) Weight (Kg.)	Ebat (mm) Dimensions (mm)	Fiyat Price
BGO	1	220-380 / 50-60	0,25 / 0,3	14	330x280x380	280 €

Patates Dilimleme Makinesi & Sanayi Tipi Konserve Açacağı

Potato Slicer & Industrial Type Can Opener

Patates Dilimleme Temel Özellikler

- 9x9 mm ölçülerinde dilimleme
- Özel alüminyum dış gövde ve elektrostatik boya
 - Paslanmaz çelik bıçaklar
 - Alüminyum dış çember

Potato Slicer Basic Features

- Slicing in 9 x 9 mm dimensions
- Special aluminum outer body and electrostatic paint
- Stainless steel blades
- Aluminum outer circle

Konserve Açacağı Temel Özellikler

- Helisel dişli sayesinde, sıyırma ve kaçırma yapmaz.
 - Ayarlanabilir sabitleme Ayağı
- Minimum kuvvet ile kullanım sağlamaktadır.

Can Opener Basic Features

- Cause of the helical gear, it does not scrape and miss.
- Adjustable fixing foot
- It provides usage with minimum force.

**PDM****SKA****Teknik Özellikler | Technical Features**

Ürün Kodu Product Code	Bıçak Ebadı Slice Dimension	Ağırlık (Kg.) Weight (Kg.)	Fiyat Price
PDM	9 x 9 mm	7,25	160 €
SKA	-	3	150 €

Gıda Dilimleme Makinası & El Blenderi

Food Slicer Machine & Hand blender

Gıda Dilimleme Temel Özellikler

- Andonize alüminyumdan imaldir. Hijyeniktir
 - Dökme alüminyum alışımlı
 - Ayarlanabilir Kesme Kalınlığı
- Bakım gerektirmeyen taşıyıcı ayağa montajlı

Food Slicer Basic Features

- It is made of andonized aluminum. hygienic
- Cast aluminum alloy
- Adjustable Cutting Thickness
- Maintenance free carrier mounted on the foot

El blender Temel Özellikler

- Çeşitli gıda ürünlerini parçalayarak karıştıran bir cihazdır.
- Sebze çorbası, sebze püresi, soslar, mayonez, domates püresi ve pesto yapar.

Hand blender Basic Featurez

- By breaking down various food products is a device that mixes.
- Vegetable soup, vegetable puree, sauces, Makes mayonnaise, tomato puree and pesto.



GDM25



BL25



BL40-C

Teknik Özellikler | Technical Features

Ürün Kodu Product Code	Bıçak Ebadı Slice Dimension	Voltaj (Volt/Hz) Voltage (Volt/Hz)	Güç (kW/hp) Power (kW/hp)	Ağırlık (Kg.) Weight (Kg.)	Ebat (cm) Dimensions (cm)	Fiyat Price
BL25	-	220 Volt / 50-60 Hz	0,25 / 0,3	-	-	360 €
BL40-C	-	220 Volt / 50-60 Hz	0,40 / 0,5	-	-	685 €
GDM25	250 Ø mm	220 Volt / 50-60 Hz	0,30 / 0,4	16	53x45x38	750 €
GDM27	270 Ø mm	220 Volt / 50-60 Hz	0,30 / 0,4	18	53x45x38	1000 €
GDM30	300 Ø mm	220 Volt / 50-60 Hz	0,30 / 0,4	21	53x50x38	1100 €



DAMPAK

Soğutma Ekipmanları

Cooling Equipments

Soğutma Ekipmanları
Cooling Equipments

Tek Kapılı Dik Tip Buzdolabı

Single Door Vertical Type Refrigerator

Temel Özellikler

- İç, dış gövde paslanmaz çelik Aisi 430 (Aisi 304 opsiyon).
- 60mm kalınlığında 37/45 kg/m³ yoğunlukta çevre dostu (CFC içermeyen) poliüretan izolasyon.
- Dijital kontrollü kumanda paneli
- Otomatik defrost özelliği.
- Yüksekliği ayarlanabilir paslanmaz ayaklar
- Ayarlanabilir polietilen kaplı raflar
- Kullanıcı tarafından sökülüp temizlenebilir manyetik kapı contası
- Yaylı menteşe sayesinde kendi kendine kapanabilir kapı.
- En23953' e göre 32°C, Rh%65 ve 41°C Rh%70 çalışma koşullarına uygun.
- Kullanıcı tercihlerine göre fanlı veya statik soğutma
- R134a, R404a soğutucu gaz
- Camlı kapılarda standart LED aydınlatma

Basic Features

- Internal, external body stainless steel Aisi 430 (Aisi 304 option).
- 60mm thick 37/45 kg / m³ density environmentally friendly (CFC-free) polyurethane insulation.
- Digitally controlled control panel
- Automatic defrosting.
- Height adjustable stainless feet
- Adjustable polyethylene coated shelves
- Can be removed and cleaned by the user magnetic door seal
- Self-closing door with spring hinge.
- Suitable for 32°C, 65% Rh and 41°C 70% RH according to EN 23953.
- Fan or static cooling according to user preferences
- R134a, R404a refrigerant
- Standard LED lighting in glass doors



Ayarlanabilir Polietilen Kaplı Raflar



Teknik Özellikler | Technical Features

Ürün Kodu Product Code	Ürün Adı Product Name	Sıcaklık (°C) Temperature (°C)	Ebat (cm) Dimensions (cm)	Hacim (Lt.) Capacity (Lt.)	Ağırlık (Kg.) Weight (Kg.)	Güç (W) Power (W)	Voltaj (Volt/Hz) Voltage (Volt/Hz)	Fiyat Price
22DBF1S-GN	Tek Kapılı Dik Tip Buzdolabı Single Door Upright Refrigerator	+2/+8	69x82x210	700	112	420	220-240 / 50-60	1250 €
22DBF1C-GN	Tek Cam Kapılı Dik Tip Buzdolabı Upright Refrigerator With Single Glass Door	+2/+8	69x82x210	700	130	420	220-240 / 50-60	1350 €
22DDF1S-GN	Tek Kapılı Dik Tip Derin Dondurucu Single Door Vertical Freezer	-15/-18	69x82x210	700	113	500	220-240 / 50-60	1650 €
22DBS1S-GN	Tek Kapılı Dik Tip Statik Buzdolabı Single Door Upright Static Refrigerator	-2/+8	69x82x210	700	105	420	220-240 / 50-60	1900 €
22DBS1S-46	Tek Kapılı Dik Tip Statik Buzdolabı 40*60 Tepsi Single Door Upright Type Static Refrigerator 40 * 60 Tray	-2/+8	69x82x210	700	113	420	220-240 / 50-60	2050 €

*Tekerek ve ekstra Raf opsiyonel olarak sunulmaktadır. Wheel and extra rack are available as an option.

**Fiyatlarımızı, ÖTV dahil değildir.

İki Kapılı Dik Tip Buzdolabı

Double Door Vertical Type Refrigerator

Temel Özellikler

- İç, dış gövde paslanmaz çelik Aisi 430 (Aisi 304 opsiyon)
- 60mm kalınlığında 37/45 kg/m³ yoğunlukta çevre dostu (CFC içermeyen) poliüretan izolasyon
- Dijital kontrollü kumanda paneli
- Otomatik defrost özelliği
- Yüksekliği ayarlanabilir paslanmaz ayaklar
- Ayarlanabilir polietilen kaplı raflar
- Kullanıcı tarafından sökülüp temizlenebilir manyetik kapı contası
- Yaylı menteşe sayesinde kendi kendine kapanabilir kapı
- En23953' e göre 32°C, Rh%65 ve 41°C Rh%70 çalışma koşullarına uygun
- Kullanıcı tercihlerine göre fanlı veya statik soğutma
- R134a, R404a soğutucu gaz
- Camlı kapılarda standart LED aydınlatma

Basic Features

- Internal, external body stainless steel Aisi 430 (Aisi 304 option)
- 60mm thickness, 37/45 kg / m³ density Eco-friendly (CFC-free) polyurethane insulation
- Digitally controlled control panel
- Automatic defrosting
- Height adjustable stainless feet
- Adjustable polyethylene coated shelves
- Can be removed and cleaned by the user magnetic door seal
- Self-closing door with spring hinge
- Suitable for 32°C, 65% Rh and 41°C 70% RH according to EN 23953
- Fan or static cooling according to user preferences
- R134a, R404a refrigerant
- Standard LED lighting in glass doors



Teknik Özellikler | Technical Features

Ürün Kodu Product Code	Ürün Adı Product Name	Sıcaklık (°C) Temperature (°C)	Ebat (cm) Dimensions (cm)	Hacim (Lt.) Capacity (Lt.)	Ağırlık (Kg.) Weight (Kg.)	Güç (W) Power (W)	Voltaaj (Volt/Hz) Voltage (Volt/Hz)	Fiyat Price
22DBF2S-GN	İki Kapılı Dik Tip Buzdolabı Two-door Upright Refrigerator	+2/+8	139x82x210	1400	205	660	220-240 / 50-60	1700 €
22DBF2C-GN	İki Cam Kapılı Dik Tip Buzdolabı Upright Refrigerator With Two Glass Doors	+2/+8	139x82x210	1400	240	660	220-240 / 50-60	1950 €
22DDF2S-GN	İki Kapılı Dik Tip Derin Dondurucu Two Door Vertical Freezer	-15/-18	139x82x210	1400	208	795	220-240 / 50-60	2150 €
22DBS2S-GN	İki Kapılı Dik Tip Statik Buzdolabı Two-door Upright Static Refrigerator	-2/+8	139x82x210	1400	195	725	220-240 / 50-60	2500 €
22DBS2S-46	İki Kapılı Dik Tip Statik Buzdolabı 40*60 Tepsisi Two Door Upright Static Refrigerator 40*60 Tray	+2/+8	139x82x210	1400	207	660	220-240 / 50-60	2750 €

*Tekerlek ve ekstra Raf opsiyonel olarak sunulmaktadır. Wheel and extra rack are available as an option.

**Fiyatlarımıza, ÖTV dahil değildir.

Et Askılı Vitrin Tip Dikey Buzdolapları

Meat Hanging, Showcase Type, Vertical Refrigerators

Temel Özellikler

- İç, dış gövde paslanmaz çelik Aisi 430 (Aisi 304 opsiyon).
 - 60mm kalınlığında 37/45 kg/m³ yoğunlukta çevre dostu (CFC içermeyen) poliüretan izolasyon.
 - Dijital kontrollü kumanda paneli
 - Otomatik defrost özelliği.
 - Yüksekliği ayarlanabilir paslanmaz ayaklar
 - Kullanıcı tarafından sökülüp temizlenebilir manyetik kapı contası
 - Yaylı menteşe sayesinde kendi kendine kapanabilir kapı.
 - En23953' e göre 32°C, Rh%65 ve 41°C Rh%70 çalışma koşullarına uygun.
 - R404a soğutucu gaz
 - Camlı kapılarda standart LED aydınlatma
- Not: Et askılı dolaplarda raf kullanılmamaktadır.**

Basic Features

- Inner, outer body stainless steel Aisi 430 (Aisi 304 option).
 - Environmentally friendly (CFC free) polyurethane insulation with 60mm thickness of 37/45 kg / m³ density.
 - Digitally controlled control panel
 - Automatic defrost feature.
 - Height adjustable stainless feet
 - Magnetic door seal which can be removed and cleaned by the user
 - Self-closing door thanks to the spring hinge.
 - According to En23953, 32 ° C, Rh 65% and 41 ° C Rh 70% suitable for working conditions.
 - R404a refrigerant
 - Standard LED lighting on glazed doors
- Note: Racks are not used in meat hung cabinets.**



22DBS1C-GN45



22DBS2C-GN45

Teknik Özellikler | Technical Features

Ürün Kodu Product Code	Ürün Adı Product Name	Sıcaklık (°C) Temperature (°C)	Ebat (cm) Dimensions (cm)	Hacim (Lt.) Capacity (Lt.)	Ağırlık (Kg.) Weight (Kg.)	Güç (W) Power (W)	Voltaj (Volt/Hz) Voltage (Volt/Hz)	Fiyat Price
22DBS1C-GN.35	Tek Kapılı, Statik (Cam Kapılı, Vitrinsiz) Single Door, Static (Glass Door, No Showcase)	-2/+8	69x82x210	602	140	660	220-240 / 50-60	2200 €
22DBS1C-GN.45	Tek Kapılı, Statik (Kapı Cam, Vitrin Cam) Single Door, Static (Door Glass, Showcase Glass)	-2/+8	69x82x210	602	160	660	220-240 / 50-60	2300 €
22DBS2C-GN.35	İki Kapılı, Statik (Kapı Cam, Vitrinsiz) Two Doors, Static (Door Glass, Stainless Showcase)	-2/+8	139x82x210	1342	240	725	220-240 / 50-60	2700 €
22DBS2C-GN.45	İki Kapılı, Statik (Kapı Cam, Vitrin Cam) Two Doors, Static (Door Glass, Showcase Glass)	-2/+8	139x82x210	1342	270	725	220-240 / 50-60	2850 €

**Fiyatlarımıza, ÖTV dahil değildir.

Tezgah Tipi Buzdolabı (1 Kapılı)

Counter Type Refrigerator (1 Door)

Temel Özellikler

- İç, dış gövde paslanmaz çelik Aisi 430 (Aisi 304 opsiyon).
- 50mm kalınlığında 37/45 kg/m³ yoğunlukta çevre dostu (CFC içermeyen) poliüretan izolasyon.
- Dijital kontrollü kumanda paneli
- Otomatik defrost özelliği.
- Yüksekliği ayarlanabilir paslanmaz ayaklar
- Ayarlanabilir polietilen kaplı raflar
- Kullanıcı tarafından sökülüp temizlenebilir manyetik kapı contası
- Yaylı menteşe sayesinde kendi kendine kapanabilir kapı.
- En23953' e göre 32°C, Rh%65 ve 41°C Rh%70 çalışma koşullarına uygun.
- R134a, R404a soğutucu gaz

Basic Features

- Inner, outer body stainless steel Aisi 430 (Aisi 304 option).
- Environmentally friendly (CFC-free) polyurethane insulation of 50mm thickness 37/45 kg / m³ density.
- Digitally controlled control panel
- Automatic defrost feature.
- Height adjustable stainless feet
- Adjustable polyethylene covered shelves
- Magnetic door seal which can be removed and cleaned by the user
- Self-closing door thanks to the spring hinge.
- According to En23953, 32°C, Rh 65% and 41°C Rh 70% suitable for working conditions.
- R134a, R404a refrigerant



22TBF1S-70

**Teknik Özellikler | Technical Features**

Ürün Kodu Product Code	Ürün Adı Product Name	Sıcaklık (°C) Temperature (°C)	Ebat (cm) Dimensions (cm)	Hacim (Lt.) Capacity (Lt.)	Ağırlık (Kg.) Weight (Kg.)	Güç (W) Power (W)	Voltaj (Volt/Hz) Voltage (Volt/Hz)	Fiyat Price
22TBF1S-60	1 Kapılı Tezgah Tipi Buzdolabı 1 Door Undercounter Refrigerator	+2/+8	100x60x85	108	75	400	220-240 / 50-60	900 €
22TBF1S-70	1 Kapılı Tezgah Tipi Buzdolabı 1 Door Undercounter Refrigerator	+2/+8	100x70x85	135	80	400	220-240 / 50-60	950 €

**Fiyatlarımıza, ÖTV dahil değildir.

Tezgah Tipi Buzdolabı (2 Kapılı)

Counter Type Refrigerator (2 Door)

Temel Özellikler

- İç, dış gövde paslanmaz çelik Aisi 430 (Aisi 304 opsiyon).
- 50mm kalınlığında 37/45 kg/m³ yoğunlukta çevre dostu (CFC içermeyen) poliüretan izolasyon.
- Dijital kontrollü kumanda paneli
- Otomatik defrost özelliği.
- Yüksekliği ayarlanabilir paslanmaz ayaklar
- Ayarlanabilir polietilen kaplı raflar
- Kullanıcı tarafından sökülüp temizlenebilir manyetik kapı contası
- Yaylı menteşe sayesinde kendi kendine kapanabilir kapı.
- En23953' e göre 32°C, Rh%65 ve 41°C Rh%70 çalışma koşullarına uygun.
- R134a, R404a soğutucu gaz
- **Granit tezgah opsiyonu.**

Basic Features

- Inner, outer body stainless steel Aisi 430 (Aisi 304 option).
- Environmentally friendly (CFC-free) polyurethane insulation of 50mm thickness 37/45 kg / m³ density.
- Digitally controlled control panel
- Automatic defrost feature.
- Height adjustable stainless feet
- Adjustable polyethylene covered shelves
- Magnetic door seal which can be removed and cleaned by the user
- Self-closing door thanks to the spring hinge.
- According to En23953, 32°C, Rh 65% and 41°C Rh 70% suitable for working conditions.
- R134a, R404a refrigerant
- **Granite countertop option.**



22TBF2S-60



Granit Tezgah Opsiyonlu | Granite Countertop Option

Teknik Özellikler | Technical Features

Ürün Kodu Product Code	Ürün Adı Product Name	Sıcaklık (°C) Temperature (°C)	Ebat (cm) Dimensions (cm)	Hacim (Lt.) Capacity (Lt.)	Ağırlık (Kg.) Weight (Kg.)	Güç (W) Power (W)	Voltaj (Volt/Hz) Voltage (Volt/Hz)	Fiyat Price
22TBF2S-60	2 Kapılı Tezgah Tipi Buzdolabı 2 Door Undercounter Refrigerator	+2/+8	150x60x85	235	90	420	220-240 / 50-60	1050 €
22TDF2S-60	2 Kapılı Tezgah Tipi Derin Dondurucu 2 Door Bench Freezer	-15/-18	150x60x85	235	92	1000	220-240 / 50-60	1470 €
22TBF2S-70	2 Kapılı Tezgah Tipi Buzdolabı 2 Door Undercounter Refrigerator	+2/+8	150x70x85	295	110	420	220-240 / 50-60	1120 €
22TDF2S-70	2 Kapılı Tezgah Tipi Derin Dondurucu 2 Door Bench Freezer	-15/-18	150x70x85	295	112	1000	220-240 / 50-60	1550 €

**Fiyatlarımıza, ÖTV dahil değildir.

Tezgah Tipi Buzdolabı (3 Kapılı)

Counter Type Refrigerator (3 Door)

Temel Özellikler

- İç, dış gövde paslanmaz çelik Aisi 430 (Aisi 304 opsiyon).
- 50mm kalınlığında 37/45 kg/m³ yoğunlukta çevre dostu (CFC içermeyen) poliüretan izolasyon.
- Dijital kontrollü kumanda paneli
- Otomatik defrost özelliği.
- Yüksekliği ayarlanabilir paslanmaz ayaklar
- Ayarlanabilir polietilen kaplı raflar
- Kullanıcı tarafından sökülüp temizlenebilir manyetik kapı contası
- Yaylı menteşe sayesinde kendi kendine kapanabilir kapı.
- En23953' e göre 32°C, Rh%65 ve 41°C Rh%70 çalışma koşullarına uygun.
- R134a, R404a soğutucu gaz
- **Granit tezgah opsiyonu.**

Basic Features

- Inner, outer body stainless steel Aisi 430 (Aisi 304 option).
- Environmentally friendly (CFC-free) polyurethane insulation of 50mm thickness 37/45 kg / m³ density.
- Digitally controlled control panel
- Automatic defrost feature.
- Height adjustable stainless feet
- Adjustable polyethylene covered shelves
- Magnetic door seal which can be removed and cleaned by the user
- Self-closing door thanks to the spring hinge.
- According to En23953, 32°C, Rh 65% and 41°C Rh 70% suitable for working conditions.
- R134a, R404a refrigerant
- **Granite countertop option.**



22TBF3S-60



Granit Tezgah Opsiyonlu | Granite Countertop Option

Teknik Özellikler | Technical Features

Ürün Kodu Product Code	Ürün Adı Product Name	Sıcaklık (°C) Temperature (°C)	Ebat (cm) Dimensions (cm)	Hacim (Lt.) Capacity (Lt.)	Ağırlık (Kg.) Weight (Kg.)	Güç (W) Power (W)	Voltaj (Volt/Hz) Voltage (Volt/Hz)	Fiyat Price
22TBF3S-60	3 Kapılı Tezgah Tipi Buzdolabı 3 Door Undercounter Refrigerator	+2/+8	200x60x85	362	110	400	220-240 / 50-60	1230 €
22TDF3S-60	3 Kapılı Tezgah Tipi Derin Dondurucu 3 Door Bench Freezer	-15/-18	200x60x85	362	112	1000	220-240 / 50-60	1650 €
22TBF3S-70	3 Kapılı Tezgah Tipi Buzdolabı 3 Door Undercounter Refrigerator	+2/+8	200x70x85	455	137	400	220-240 / 50-60	1350 €
22TDF3S-70	3 Kapılı Tezgah Tipi Derin Dondurucu 3 Door Bench Freezer	-15/-18	200x70x85	455	139	1000	220-240 / 50-60	1800 €

**Fiyatlarımıza, ÖTV dahil değildir.

Tezgah Tipi Çekmeceli Buzdolapları

Counter Type Drawer Refrigerators

Temel Özellikler

- İç, dış gövde paslanmaz çelik Aisi 430 (Aisi 304 opsiyon).
- 50mm kalınlığında 37/45 kg/m³ yoğunlukta çevre dostu (CFC içermeyen) poliüretan izolasyon.
- Dijital kontrollü kumanda paneli
- Otomatik defrost özelliği.
- Yüksekliği ayarlanabilir paslanmaz ayaklar
- Kullanıcı tarafından sökülüp temizlenebilir çekmece ve manyetik kapı contası
- En23953' e göre 32°C, Rh%65 ve 41°C Rh%70 çalışma koşullarına uygun.
- R134a, soğutucu gaz

Basic Features

- Inner, outer body stainless steel Aisi 430 (Aisi 304 option).
- Environmentally friendly (CFC-free) polyurethane insulation of 50mm thickness 37/45 kg / m³ density.
- Digitally controlled control panel
- Automatic defrost feature.
- Height adjustable stainless feet
- Drawer and magnetic door gasket that can be removed and cleaned by the user
- According to En23953, 32°C, Rh 65% and 41°C Rh 70% suitable for working conditions.
- R134a, refrigerant gas



22BFOS-60.4C



Granit Tezgah Opsiyonlu | Granite Countertop Option

Teknik Özellikler | Technical Features

Ürün Kodu Product Code	Ürün Adı Product Name	Sıcaklık (°C) Temperature (°C)	Ebat (cm) Dimensions (cm)	Hacim (Lt.) Capacity (Lt.)	Ağırlık (Kg.) Weight (Kg.)	Güç (W) Power (W)	Voltaj (Volt/Hz) Voltage (Volt/Hz)	Fiyat Price
22BFOS-60.4C	Tezgahlı 4 Çekmeceli Buzdolabı Undercounter 4 Drawer Refrigerator	+2/+8	150x60x85	108	105	420	220-240 / 50-60	1850 €
22BFOS-70.4C	Tezgahlı 4 Çekmeceli Buzdolabı Undercounter 4 Drawer Refrigerator	+2/+8	150x70x85	108	125	420	220-240 / 50-60	1950 €
22BFOS-60.6C	Tezgahlı 6 Çekmeceli Buzdolabı Undercounter 6 Drawer Refrigerator	+2/+8	200x60x85	108	130	460	220-240 / 50-60	2250 €
22BFOS-70.6C	Tezgahlı 6 Çekmeceli Buzdolabı Undercounter 6 Drawer Refrigerator	+2/+8	200x70x85	135	145	460	220-240 / 50-60	2360 €

**Fiyatlarımıza, ÖTV dahil değildir.

Cihaz Altı Çekmeceli Buzdolapları

Under Device Drawer Refrigerators

Temel Özellikler

- İç, dış gövde paslanmaz çelik Aisi 430 (Aisi 304 opsiyon).
- 50mm kalınlığında 37/45 kg/m³ yoğunlukta çevre dostu (CFC içermeyen) poliüretan izolasyon.
- Dijital kontrollü kumanda paneli
- Yüksekliği ayarlanabilir paslanmaz ayaklar
- Kullanıcı tarafından sökülüp temizlenebilir çekmece ve manyetik kapı contası.
- En23953'e göre 32°C, Rh%65 ve 41°C Rh%70 çalışma koşullarına uygun.
- R134a soğutucu gaz

Basic Features

- Inner, outer body stainless steel Aisi 430 (Aisi 304 option).
- Environmentally friendly (CFC-free) polyurethane insulation of 50mm thickness 37/45 kg / m³ density.
- Digitally controlled control panel
- Height adjustable stainless feet
- Drawer and magnetic door gasket that can be removed and cleaned by the user.
- According to En23953, 32°C, Rh 65% and 41°C Rh 70% suitable for working conditions.
- R134a refrigerant



22CBS0S-60.4C



Teknik Özellikler | Technical Features

Ürün Kodu Product Code	Ürün Adı Product Name	Sıcaklık (°C) Temperature (°C)	Ebat (cm) Dimensions (cm)	Hacim (Lt.) Capacity (Lt.)	Ağırlık (Kg.) Weight (Kg.)	Voltaj (Volt/Hz) Voltage (Volt/Hz)	Fiyat(Kapılı) Price (Door)	Fiyat(Çekmeceli) Price (Drawer)
22CBS0S-60.4C	Cihazaltı Buzdolabı Under Cabinet Refrigerator	+2/+8	150x60x60	139	74	220-240 / 50-60	1450 €	1600 €
22CBS0S-70.4C	Cihazaltı Buzdolabı Under Cabinet Refrigerator	+2/+8	150x70x60	174	92	220-240 / 50-60	1550 €	1700 €
22CBS0S-60.6C	Cihazaltı Buzdolabı Under Cabinet Refrigerator	+2/+8	200x60x60	214	109	220-240 / 50-60	1650 €	1800 €
22CBS0S-70.6C	Cihazaltı Buzdolabı Under Cabinet Refrigerator	+2/+8	200x70x60	269	117	220-240 / 50-60	1980 €	2200 €

**Fiyatlarımıza, ÖTV dahil değildir.

Pizza Hazırlık Buzdolabı (Alçak Model)

Pizza preparation fridge (Low Model)

Temel Özellikler

- İç, dış gövde paslanmaz çelik Aisi 430 (Aisi 304 opsiyon).
- 50mm kalınlığında 37/45 kg/m³ yoğunlukta çevre dostu (CFC içermeyen) poliüretan izolasyon.
- Dijital kontrollü kumanda paneli
- Otomatik defrost özelliği.
- Yüksekliği ayarlanabilir paslanmaz ayaklar
- Ayarlanabilir polietilen kaplı raflar
- Kullanıcı tarafından sökülüp temizlenebilir, manyetik kapı contası
- Yaylı menteşe sayesinde kendi kendine kapanabilir kapı.
- En23953' e göre 32°C, Rh%65 ve 41°C Rh%70 çalışma koşullarına uygun.
- R134a, R404a soğutucu gaz
- Make up GN 1/4

Basic Features

- Inner, outer body stainless steel Aisi 430 (Aisi 304 option).
- Environmentally friendly (CFC-free) polyurethane insulation of 50mm thickness 37/45 kg / m³ density.
- Digitally controlled control panel
- Automatic defrost feature.
- Height adjustable stainless feet
- Adjustable polyethylene covered shelves
- Magnetic door seal which can be removed and cleaned by the user
- Self-closing door thanks to the spring hinge.
- According to En23953, 32°C, Rh 65% and 41°C Rh 70% suitable for working conditions.
- R134a, R404a refrigerant
- Make up GN 1/4



22TBF2S-PA70



22TBF3S-PA70



Teknik Özellikler | Technical Features

Ürün Kodu Product Code	Ürün Adı Product Name	Sıcaklık (°C) Temperature (°C)	Ebat (cm) Dimensions (cm)	Hacim (Lt.) Capacity (Lt.)	Ağırlık (Kg.) Weight (Kg.)	Güç (W) Power (W)	Voltaj (Volt/Hz) Voltage (Volt/Hz)	Fiyat Price
22TBF1S-PA70	1 Kapılı Tezgah Altı Kısa Pizza Hazırlık Buzdolabı 1 Door UnderCounter Short Pizza Preparation Refrigerator	+2/+8	100x70x109	196	105	450	220-240 / 50-60	1370 €
22TBF2S-PA70	2 Kapılı Tezgah Altı Kısa Pizza Hazırlık Buzdolabı 2 Door UnderCounter Short Pizza Preparation Refrigerator	+2/+8	150x70x109	290	115	450	220-240 / 50-60	1610 €
22TBF3S-PA70	3 Kapılı Tezgah Altı Kısa Pizza Hazırlık Buzdolabı 3 Doors UnderCounter Short Pizza Preparation Refrigerator	+2/+8	200x70x109	450	130	450	220-240 / 50-60	1700 €

**Fiyatlarımıza, ÖTV dahil değildir.

Pizza Hazırlık Buzdolabı (Yüksek Model)

Pizza Preparation Refrigerator (High Model)

Temel Özellikler

- İç, dış gövde paslanmaz çelik Aisi 430 (Aisi 304 opsiyon).
- 50mm kalınlığında 37/45 kg/m³ yoğunlukta çevre dostu (CFC içermeyen) poliüretan izolasyon.
- Dijital kontrollü kumanda paneli
- Otomatik defrost özelliği.
- Yüksekliği ayarlanabilir paslanmaz ayaklar
- Ayarlanabilir polietilen kaplı raflar
- Kullanıcı tarafından sökülüp temizlenebilir manyetik kapı contası
- Yaylı menteşe sayesinde kendi kendine kapanabilir kapı.
- En23953' e göre 32°C, Rh%65 ve 41°C Rh%70 çalışma koşullarına uygun.
- R134a, R404a soğutucu gaz
- Granit tezgah opsiyonu.
- Make up GN 1/4

Basic Features

- Inner, outer body stainless steel Aisi 430 (Aisi 304 option).
- Environmentally friendly (CFC-free) polyurethane insulation of 50mm thickness 37/45 kg / m³ density.
- Digitally controlled control panel
- Automatic defrost feature.
- Height adjustable stainless feet
- Adjustable polyethylene covered shelves
- Magnetic door seal which can be removed and cleaned by the user
- Self-closing door thanks to the spring hinge.
- According to En23953, 32°C, Rh 65% and 41°C Rh 70% suitable for working conditions.
- R134a, R404a refrigerant
- Granite countertop option.
- Make up GN 1/4



22CBS0S-60.4C



22CBS0S-60.4C



Granit Tezgah Opsiyonlu | Granite Countertop Option

Teknik Özellikler | Technical Features

Ürün Kodu Product Code	Ürün Adı Product Name	Sıcaklık (°C) Temperature (°C)	Ebat (cm) Dimensions (cm)	Hacim (Lt.) Capacity (Lt.)	Ağırlık (Kg.) Weight (Kg.)	Güç (W) Power (W)	Voltaj (Volt/Hz) Voltage (Volt/Hz)	Fiyat Price
22TBF1S-PY70	1 Kapılı Tezgah Altı Yüksek Pizza Hazırlık Buzdolabı 1 Door UnderCounter High Pizza Preparation Refrigerator	+2/+8	100x70x133	196	115	450	220-240 / 50-60	1600 €
22TBF2S-PY70	2 Kapılı Tezgah Altı Yüksek Pizza Hazırlık Buzdolabı 2 Door UnderCounter High Pizza Preparation Refrigerator	+2/+8	150x70x133	290	130	450	220-240 / 50-60	1850 €
22TBF3S-PY70	3 Kapılı Tezgah Altı Yüksek Pizza Hazırlık Buzdolabı 3 Doors UnderCounter High Pizza Preparation Refrigerator	+2/+8	200x70x133	450	145	450	220-240 / 50-60	1950 €

**Fiyatlarımıza, ÖTV dahil değildir.

Banket Arabaları(Soğuk)

Banquet Trolleys (Soğuk)

Temel Özellikler

- İç, dış gövde paslanmaz çelik Aisi 430 (304 Opsiyonel)
- 60mm kalınlığında 37/45 kg/m³ yoğunlukta çevre dostu (CFC içermeyen) poliüretan izolasyon.
- Dijital kontrollü kumanda paneli
- Her yöne dönebilir ikisi kilitli 4 adet tekerlek
- Kullanıcı tarafından sökülüp temizlenebilir manyetik kapı contası

Basic Features

- Inner, outer body stainless steel Aisi 430 (304 Optional)
- Environmentally friendly (CFC free) polyurethane insulation with 60mm thickness of 37/45 kg / m³ density.
- Digitally controlled control panel
- 4 wheels, two of which can be rotated in all directions
- Door gasket that can be removed and cleaned by the user



22B001SO-GN



22B002SO-GN



2/1 Gastronom Dizayn

2/1 Gastronom Design

Teknik Özellikler | Technical Features

Ürün Kodu Product Code	Ürün Adı Product Name	Sıcaklık (°C) Temperature (°C)	Ebat (cm) Dimensions (cm)	Hacim (Lt.) Capacity (Lt.)	Ağırlık (Kg.) Weight (Kg.)	Tepsi Tray	Voltaj (Volt/Hz) Voltage (Volt/Hz)	Fiyat Price
22B001SO-GN	1 Kapılı Soğuk Banket Kabini Gastronom Tepsi 1 Door Cold Banquet Cabin Gastronom Tray	+2/+8	675x800x1720	462	110	15	220-240 / 50-60	2150 €
22B002SO-GN	2 Kapılı Soğuk Banket Kabini Gastronom Tepsi 2 Door Cold Banquet Cabinet Gastronom Tray	+2/+8	1290x800x1720	925	190	30	220-240 / 50-60	3650 €

**Fiyatlarımızza, ÖTV dahil değildir.

Banquet Arabaları (Sıcak)

Banquet Trolleys (Sıcak)

Temel Özellikler

- İç, dış gövde paslanmaz çelik Aisi 430 (304 Opsiyonel)
- 60mm kalınlığında 37/45 kg/m³ yoğunlukta çevre dostu (CFC içermeyen) poliüretan izolasyon.
- Dijital kontrollü kumanda paneli
- 65°-70°C aralığında ısıtma
- Her yöne dönebilir ikisi kilitli 4 adet tekerlek
- Kullanıcı tarafından sökülüp temizlenebilir ısıya dayanıklı manyetik kapı contası

Basic Features

- Inner, outer body stainless steel Aisi 430 (304 Optional)
- Environmentally friendly (CFC free) polyurethane insulation with 60mm thickness of 37/45 kg / m³ density.
- Digitally controlled control panel
- Heating in the range of 65 ° -70 ° C
- 4 wheels, two of which can be rotated in all directions
- Heat resistant magnetic door gasket that can be removed and cleaned by the user



22B001S-GN



22B002S-GN

**2/1 Gastronom Dizayn**

2/1 Gastronom Design

Teknik Özellikler | Technical Features

Ürün Kodu Product Code	Ürün Adı Product Name	Sıcaklık (°C) Temperature (°C)	Ebat (cm) Dimensions (cm)	Hacim (Lt.) Capacity (Lt.)	Ağırlık (Kg.) Weight (Kg.)	Tepsi Tray	Voltaj (Volt/Hz) Voltage (Volt/Hz)	Fiyat Price
22B001S-GN	1 Kapılı Sıcak Banquet Kabini Gastronom Tepsi 1 Door Hot Banquet Cabinet Gastronom Tray	+60/+70	675x800x1720	462	93	15	220-240 / 50-60	1400 €
22B002S-GN	2 Kapılı Sıcak Banquet Kabini Gastronom Tepsi 2 Door Hot Banquet Cabinet Gastronom Tray	+60/+70	1290x800x1720	925	170	30	220-240 / 50-60	1950 €
22B001S-GN1/1	1 Kapılı Sıcak Banquet Kabini Gastronom Tepsi 1 Door Hot Banquet Cabinet Gastronom Tray	+60/+70	500x775x1720	-	105	13	220-240 / 50-60	1300 €

**Fiyatlarımıza, ÖTV dahil değildir.

Set Üstü Saladbar

Set Top Saladbar

Temel Özellikler

- Dış gövde paslanmaz çelik Aisi 430, İç gövde Aisi 304 opsiyon.
- 40mm kalınlığında 37/45 kg/m³ yoğunlukta çevre dostu (CFC içermeyen) poliüretan izolasyon.
- Dijital kontrollü kumanda paneli.
- +2°C / +10°C çalışma aralığı.
- GN 1/4 Küvet
- En23953' e göre 32°C, Rh%65 ve 41°C Rh%70 çalışma koşullarına uygun.
- R134a, soğutucu gaz.
- Statik soğutmalı yüksek performanslı soğutma ünitesi
- Opsiyonlu üst koruma dizayn. Cam, plexiglass koruma veya paslanmaz kapak.

Basic Features

- Outer body stainless steel Aisi 430, Inner body Aisi 304 options.
- Environmentally friendly (CFC-free) polyurethane insulation of 40mm thickness 37/45 kg / m³ density.
- Digitally controlled control panel.
- +2°C / +10°C operating range.
- GN 1/4 Tub
- According to En23953, 32°C, Rh 65% and 41°C Rh 70% suitable for working conditions.
- R134a, refrigerant.
- Static cooled high performance cooling unit
- Optional top protection design. Glass, plexiglass protection or stainless cover.



22SBS05-12



22SBS07-15



22SBS09-18

Teknik Özellikler | Technical Features

Ürün Kodu Product Code	Ürün Adı Product Name	Sıcaklık (°C) Temperature (°C)	Ebat (cm) Dimensions (cm)	Hacim (Lt.) Capacity (Lt.)	Ağırlık (Kg.) Weight (Kg.)	Güç (W) Power (W)	Voltaj (Volt/Hz) Voltage (Volt/Hz)	Fiyat Price
22SBS05-12	Soğutmalı Set Üstü Saladbar 120cm Gn 1/4 5 Küvet Refrigerated Cooktop Saladbar 120cm Gn 1/4 5 Containers	+2/+10	120x35x40	29	27	75	220-240 / 50-60	650 €
22SBS07-15	Soğutmalı Set Üstü Saladbar 150cm Gn 1/4 7 Küvet Refrigerated Cooktop Saladbar 150cm Gn 1/4 7 Containers	+2/+10	150x35x40	41	30	75	220-240 / 50-60	690 €
22SBS09-18	Soğutmalı Set Üstü Saladbar 180cm Gn 1/4 9 Küvet Refrigerated Cooktop Saladbar 180cm Gn 1/4 9 Containers	+2/+10	180x35x40	52	35	75	220-240 / 50-60	730 €
22SBS10-20	Soğutmalı Set Üstü Saladbar 200cm Gn 1/4 10 Küvet Refrigerated Cooktop Saladbar 200cm Gn 1/4 10 Containers	+2/+10	200x35x40	59	40	75	220-240 / 50-60	750 €

**Fiyatlarımızı, ÖTV dahil değildir.

Pasta Teşhir Dolabı (Soğutmalı)

Cake Display Cabinet (Refrigerated)

Temel Özellikler

- İç, dış gövde paslanmaz çelik Aisi 430 (Aisi 304 opsiyon).
- 60mm kalınlığında 37/45 kg/m³ yoğunlukta çevre dostu (CFC içermeyen) poliüretan izolasyon.
- Dijital kontrollü kumanda paneli
- Otomatik defrost özelliği.
- R134a, R404a soğutucu gaz
- Her yöne dönebilir ikisi kilitli 4 adet tekerlek
- En23953' e göre 32°C, Rh%65 ve 41°C Rh%70 çalışma koşullarına uygun.
- Kullanıcı tercihlerine göre düz veya bombe ön camlı.
- Cam raflar
- Standart LED aydınlatma

Basic Features

- Inner, outer body stainless steel Aisi 430 (Aisi 304 option).
- Environmentally friendly (CFC free) polyurethane insulation with 60mm thickness of 37/45 kg / m³ density.
- Digitally controlled control panel
- Automatic defrost feature.
- R134a, R404a refrigerant
- 4 wheels, two of which can be rotated in all directions
- According to En23953, 32°C, Rh 65% and 41°C Rh 70% suitable for working conditions.
- Flat or cambered windshield according to user preferences.
- Glass shelves
- Standard LED lighting



22POF3B-S0



22POF3D-S0

Teknik Özellikler | Technical Features

Ürün Kodu Product Code	Ürün Adı Product Name	Sıcaklık (°C) Temperature (°C)	Ebat (cm) Dimensions (cm)	Hacim (Lt.) Capacity (Lt.)	Ağırlık (Kg.) Weight (Kg.)	Güç (W) Güç (W)	Voltaj (Volt/Hz) Voltage (Volt/Hz)	Fiyat Price
22POF0B-S0	Soğuk Pasta Teşhir Dolabı 100 Bombe Camlı Cold Pastry Display Cabinet 100 with Curved Glass	+4/+8	100x70x130	370	140	500	220-240 / 50-60	1600 €
22POF3B-S0	Soğuk Pasta Teşhir Dolabı 130 Bombe Camlı Cold Pastry Display Cabinet 130 with Curved Glass	+4/+8	130x70x130	480	170	600	220-240 / 50-60	2000 €
22POF6B-S0	Soğuk Pasta Teşhir Dolabı 160 Bombe Camlı Cold Pastry Display Cabinet 160 with Curved Glass	+4/+8	160x70x130	590	210	700	220-240 / 50-60	2400 €
22POF0D-S0	Soğuk Pasta Teşhir Dolabı 100 Düz Camlı Cold Pastry Display Cabinet 100 Flat Glass	+4/+8	100x70x130	429	150	500	220-240 / 50-60	1600 €
22POF3D-S0	Soğuk Pasta Teşhir Dolabı 130 Düz Camlı Cold Pastry Display Cabinet 130 Flat Glass	+4/+8	130x70x130	562	180	600	220-240 / 50-60	2000 €
22POF6D-S0	Soğuk Pasta Teşhir Dolabı 160 Düz Camlı Cold Pastry Display Cabinet 160 Flat Glass	+4/+8	160x70x130	695	220	700	220-240 / 50-60	2400 €

**Fiyatlarımıza, ÖTV dahil değildir.

Teşhir Dolabı (Isıtmalı) Display Cabinet (Refrigerated)

Temel Özellikler

- İç, dış gövde paslanmaz çelik Aisi 430 (Aisi 304 opsiyon).
- 60mm kalınlığında 37/45 kg/m³ yoğunlukta çevre dostu (CFC içermeyen) poliüretan izolasyon.
- Dijital kontrollü kumanda paneli
- İsteğe bağlı olarak nötr veya sıcak çalıştırılabilir
- Her yöne dönebilir ikisi kilitli 4 adet tekerlek
- Kullanıcı tercihlerine göre düz veya bombe ön camlı.
- Cam raflar
- Standart LED aydınlatma

Basic Features

- Inner, outer body stainless steel Aisi 430 (Aisi 304 option).
- Environmentally friendly (CFC free) polyurethane insulation with 60mm thickness of 37/45 kg / m³ density.
- Digitally controlled control panel
- Optionally, it can be operated neutral or hot
- 4 wheels, two of which can be rotated in all directions
- Flat or cambered windshield according to user preferences.
- Glass shelves
- Standard LED lighting



22POF3B-SC



22POF3D-SC

Teknik Özellikler | Technical Features

Ürün Kodu Product Code	Ürün Adı Product Name	Sıcaklık (°C) Temperature (°C)	Ebat (cm) Dimensions (cm)	Hacim (Lt.) Capacity (Lt.)	Ağırlık (Kg.) Weight (Kg.)	Güç(W) Güç(W)	Voltaj (Volt/Hz) Voltage (Volt/Hz)	Fiyat Price
22POF0B-SC	Isıtmalı Teşhir Dolabı 100 Bombe Camlı Heated Display Cabinet 100 with Curved Glass	Max.70°C	100x70x130	370	110	1000	220-240 / 50-60	1370 €
22POF3B-SC	Isıtmalı Teşhir Dolabı 130 Bombe Camlı Heated Display Cabinet 130 with Curved Glass	Max.70°C	130x70x130	480	140	1000	220-240 / 50-60	1530 €
22POF6B-SC	Isıtmalı Teşhir Dolabı 160 Bombe Camlı Heated Display Cabinet 160 with Curved Glass	Max.70°C	160x70x130	590	180	1300	220-240 / 50-60	1700 €
22POF0D-SC	Isıtmalı Teşhir Dolabı 100 Düz Camlı Heated Display Cabinet 100 Flat Glass	Max.70°C	100x70x130	429	120	1000	220-240 / 50-60	1370 €
22POF3D-SC	Isıtmalı Teşhir Dolabı 130 Düz Camlı Heated Display Cabinet 130 Flat Glass	Max.70°C	130x70x130	562	150	1000	220-240 / 50-60	1530 €
22POF6D-SC	Isıtmalı Teşhir Dolabı 160 Düz Camlı Heated Display Cabinet 160 Flat Glass	Max.70°C	160x70x130	695	190	1300	220-240 / 50-60	1700 €

**Fiyatlarımıza, ÖTV dahil değildir.

Setüstü Teşhir Dolabı

Countertop Display Cabinet

Temel Özellikler (Soğuk)

- İç, dış gövde paslanmaz çelik Aisi 430 (Aisi 304 opsiyon).
- Dijital kontrollü kumanda paneli
- Otomatik defrost özelliği.
- R134a soğutucu gaz
- En23953' e göre 32°C, Rh%65 ve 41°C Rh%70 çalışma koşullarına uygun.
- Standart LED aydınlatma
- Kromaj kaplama raflar

Basic Features (Cool)

- Inner, outer body stainless steel Aisi 430 (Aisi 304 option).
- Digitally controlled control panel
- Automatic defrost feature.
- R134a refrigerant
- According to En23953, 32°C, Rh 65% and 41°C Rh 70% suitable for working conditions.
- Standard LED lighting
- Chrome plated shelves

Temel Özellikler (Sıcak)

- İç, dış gövde paslanmaz çelik Aisi 430 (Aisi 304 opsiyon).
- Dijital kontrollü kumanda paneli
- İsteğe bağlı olarak nötr veya sıcak çalıştırılabilir
- Standart LED aydınlatma
- Kromaj kaplama raflar

Basic Features (Hot)

- Inner, outer body stainless steel Aisi 430 (Aisi 304 option).
- Digitally controlled control panel
- Optionally, it can be operated neutral or hot
- Standard LED lighting
- Chrome plated shelves



Teknik Özellikler (Soğuk) | Technical Features (Cool)

Ürün Kodu Product Code	Ürün Adı Product Name	Sıcaklık (°C) Temperature (°C)	Ebat (cm) Dimensions (cm)	Hacim (Lt.) Capacity (Lt.)	Ağırlık (Kg.) Weight (Kg.)	Gaz Türü Refrigerant	Voltaj (Volt/Watt) Voltage (Volt/Watt)	Fiyat Price
22DSS-80	Setüstü Soğuk Teşhir Dolabı Set Top Cold Display Cabinet	0 / +12	80x60x70	140	65	R134A	220 / 20	1050 €
22DSS-120	Setüstü Soğuk Teşhir Dolabı Set Top Cold Display Cabinet	0 / +12	120x60x70	200	85	R404A	220 / 20	1200 €
22DSI-80	Setüstü Sıcak Teşhir Dolabı Countertop Hot Display Cabinet	+40 / +60	80x60x70	140	65	R134A	220 / 800	900 €
22DSI-120	Setüstü Sıcak Teşhir Dolabı Countertop Hot Display Cabinet	+40 / +60	120x60x70	200	85	R404A	220 / 800	1000 €

**Fiyatlarımıza, ÖTV dahil değildir.

Orta Tip Soğutuculu Salad Bar & Ayran Makinesi

Middle Type Refrigerated Salad Bar & Buttermilk Machine

Salad Bar Temel Özellikler

- Ayran teşhir ve soğuk servis amaçlı,
- Gıda tüzüğüne uygun malzemeden üretilmiştir.
- İç, dış gövde paslanmaz çelik Aisi 430 (Aisi 304 opsiyon).
- 40mm kalınlığında 37/45 kg/m³ yoğunlukta çevre dostu (CFC içermeyen) poliüretan izolasyon.
- Dijital kontrollü kumanda paneli
- R134a soğutucu gaz
- Köpük sağlayan devir daim pompası
- Musluktan ve/veya keçe ile bardaklara ayran dolumu.

Salad Bar Basic Features

- Buttermilk for display and cold service,
- It is made of materials that comply with the food regulations.
- Inner, outer body stainless steel Aisi 430 (Aisi 304 option).
- Environmentally friendly (CFC-free) polyurethane insulation of 40mm thickness 37/45 kg / m³ density.
- Digitally controlled control panel
- R134a refrigerant
- Foam circulating pump
- Filling the buttermilk from the tap and / or scoop into glasses.

Ayran Makinesi Temel Özellikler

- Dijital kontrollü kumanda paneli
- Otomatik defrost özelliği.
- Her yöne dönebilir ikisi kilitli 4 adet tekerlek
- R134a soğutucu gaz, statik soğutma.

Buttermilk Machine Basic Features

- Digitally controlled control panel
- Automatic defrost feature.
- 4 wheels, two of which can be rotated in all directions
- R134a refrigerant gas, static cooling.



M044 (Açık)



M044-1



AYRMKN-50

Ürün Kodu Product Code	Ürün Adı Product Name	Sıcaklık (°C) Temperature (°C)	Ebat (cm) Dimensions (cm)	Ağırlık (Kg.) Weight (Kg.)	Güç(W) Güç(W)	Voltaj (Volt/Hz) Voltage (Volt/Hz)	Fiyat Price	
M044 (Açık)	Orta Tip Soğutuculu Salatbar Medium Type Refrigerated Salatbar	0 / +4	150x90x85/130	125	900	220-240 / 50-60	1330 €	
M044-1	Orta Tip Soğutuculu Salatbar Medium Type Refrigerated Salatbar	0 / +4	150x90x85/130	140	900	220-240 / 50-60	1540 €	
Ürün Kodu Product Code	Ürün Adı Product Name	Sıcaklık (°C) Temperature (°C)	Ebat (cm) Dimensions (cm)	Hacim (Lt.) Capacity (Lt.)	Ağırlık (Kg.) Weight (Kg.)	Güç(W) Güç(W)	Voltaj (Volt/Hz) Voltage (Volt/Hz)	Fiyat Price
AYRMKN-50	Ayran Makinesi Buttermilk Machine	+2 / +4	60x60x85/151	50	65	110	220-240 / 50-60	1120 €

**Fiyatlarımızza, ÖTV dahil değildir.

Reyon Dolabı

Serve-Over Counter

Temel Özellikler

- Et ve şarküteri için kullanılabilir
- İçten motorlu
- Fanlı soğutma
- Elektronik termostat
- Poliüretan gövde
- Paslanmaz çelik iç kaplama
- Paslanmaz çelik çalışma tezgahı
- Amortisörlü açılabilir temperli camlar sayesinde yüklenme ve temizlik kolaylığı
- Aydınlatma sistemi

Basic Features

- Used for meat, sausages and delicatessen
- Plug-in version
- Fan assisted refrigeration
- Electronic thermostat
- Polyurethane injected body
- Stainless steel inner coating
- Stainless steel working plate
- Upward opening tempered glasses provide easy cleaning and maintenance
- Light system



Ürün Kodu Product Code	Ürün Adı Product Name	Soğutma Kapasitesi Cooling Capacity	Ebat (mm) Dimensions (mm)	Güç (W) Güç (W)	Komp. Gücü (Hp) Comp. Power (Hp)	Voltaj (Volt/Hz) Voltage (Volt/Hz)	Fiyat Price
LET00-1212125	Leto (İçten motorlu / Plug-in)	714 Watt	1350x1200x1275	704	1/2	230 / 50-60	2850 €
LET00-1212187	Leto (İçten motorlu / Plug-in)	1266 Watt	1975x1200x1275	843	3/4	230 / 50-60	3800 €
LET00-1212250	Leto (İçten motorlu / Plug-in)	1572 Watt	2600x1200x1275	1150	1	230 / 50-60	4400 €
LET00-1212281	Leto (İçten motorlu / Plug-in)	2238 Watt	2910x1200x1275	1443	1.3	230 / 50-60	5100 €
LET00-1212375	Leto (İçten motorlu / Plug-in)	2951 Watt	3850x1200x1275	1753	1.5	230 / 50-60	6100 €

**Fiyatlarımıza, ÖTV dahil değildir.

Sütlük Dolabı

Vertical Cabinet

Temel Özellikler

- Paket et, şarküteri ve meşrubat için kullanılabilir
- İçten motorlu
- Fanlı soğutma
- Elektronik termostat
- Poliüretan gövde
- Paslanmaz zemin tepsileri
- Elektrostatik toz boyalı raflar ve arka üfleme panelleri
- Isıcamlı çarpma kapı
- Plastik etiketlik
- Aydınlatma sistemi

Basic Features

- Used for packaged meat, sausages and delicatessen
- Plug-in version
- Fan assisted refrigeration
- Electronic thermostat
- Polyurethane injected body
- Stainless steel base trays
- Electrostatic powder painted shelves and back panels
- Hinged doors with double-glazed glasses
- Plastic label holder
- Light system



Ürün Kodu Product Code	Ürün Adı Product Name	Soğutma Kapasitesi Cooling Capacity	Ebat (mm) Dimensions (mm)	Güç (W) Güç (W)	Komp. Gücü (Hp) Comp. Power (Hp)	Brüt Hacim Volume	Voltaj (Volt/Hz) Voltage (Volt/Hz)	Fiyat Price
SRN00-2007156	Saron (İçten motorlu / Plug-in) 2 Kapılı / 2 Doors	1450 Watt	1662x705x2000	1275	1	2,2 Lt.	230 / 50-60	3650 €
SRN00-2007234	Saron (İçten motorlu / Plug-in) 3 Kapılı / 3 Doors	2240 Watt	2443x705x2000	1895	1.3	3,1 Lt.	230 / 50-60	4900 €
SRN00-2007312	Saron (İçten motorlu / Plug-in) 4 Kapılı / 4 Doors	2980 Watt	3220x705x2000	2240	1.5	3,8 Lt.	230 / 50-60	6650 €
SRN00-2007390	Saron (İçten motorlu / Plug-in) 5 Kapılı / 5 Doors	3850 Watt	4005x705x2000	3150	2.5	4,9 Lt.	230 / 50-60	7950 €

**Fiyatlarımızza, ÖTV dahil değildir.

Soğuk Oda

Cold Room

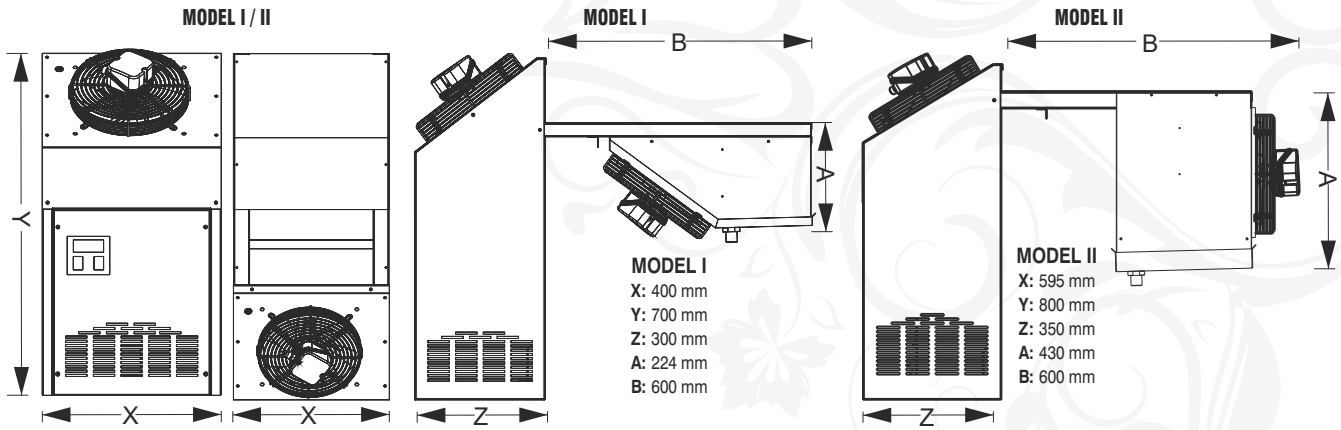

Teknik Özellikler | Technical Features

Ürün Kodu Product Code	Voltaj (V/Hz) Voltage (V/Hz)	Evaporasyon/Ortam Sıc. Evaporation / Ambient Temp.	Kapasite (W) Capacity (W)	Güç (W) Power (W)	Hacim (m ³) Volume (m ³)	Model Model	Oda Ebadı (cm) Room Dim. (cm)	Fiyat Price
M011-M01.SZ4130.NE6210U.EP5	220-240 / 50-60	-5/+32 °C	922	378	8	I	150x150x220	5250 €
M011-M01.SZ4130.NE6210U.EP5	220-240 / 50-60	-5/+32 °C	922	378	8	I	150x210x220	5950 €
M018-M01.SZ4130.NE6214U.EP5	220-240 / 50-60	-5/+32 °C	1143	474	12	I	150x300x220	6950 €
L012-M02.SZ4130.NT2180U.EP5	220-240 / 50-60	-25/+32 °C	844	498	8	II	150x150x220	6250 €
L012-M02.SZ4130.NT2180U.EP5	220-240 / 50-60	-25/+32 °C	844	498	8	II	150x210x220	6950 €
L015-M02.SZ4130.NE2210U.EP5	220-240 / 50-60	-25/+32 °C	1041	602	10	II	150x300x220	9250 €

**Fiyatlarımıza, ÖTV dahil değildir.

Buz Makineleri

Ice Makers

Temel Özellikler

- Püskürtmeli sistem.
- Kolay temizlenebilen yüzeyler.
- Anti bakteriyel iç gövde.
- Elektronik kontrol.
- Geniş saklama hacmi.
- Hava soğutmalı sistem.
- Tropikal iklim sınıfı.
- Kolay temizlenebilir hava filtresi.
- Entegre tutamaklı ve izolasyonlu kapı.
- Düşük su tüketimi.
- Verimli kompresörler.
- Poliüretan izolasyonlu gövde.
- Drenaj pompalı servis kiti

Basic Features

- Sprayer system.
- EasyClean Surfaces.
- Anti-Bacterial InnerBody.
- Electronic Control.
- Large Ice Storage Space.
- Air Cooled System.
- Tropical Climate Type.
- Easy Clean Air Filter.
- Door With Integrated and Isolated Handle.
- Low Water Consumption.
- Efficient Compressors.
- Polyurethane Isolated Body
- Service Kit With Drain Pump.



FR25 LSI



FR50 LSI & FR35 LSI



FR70 LSI & FR90 LSI

Teknik Özellikler | Technical Features

Ürün Kodu Product Code	Fr25 LSI	Fr35 LSI	Fr50 LSI	Fr70 LSI	Fr90 LSI
Üretim kapasitesi (kg) Production Capacity (kg)	22	32	47	67	85
Depolama kapasitesi (kg) Storage Capacity (kg)	4	16	28	40	40
Buz tipi Ice Type	Özel Büyük Buz Large Special Ice	Özel Büyük Buz Large Special Ice	Özel Büyük Buz Large Special Ice	Özel Büyük Buz Large Special Ice	Özel Büyük Buz Large Special Ice
Soğutma Sistemi Cooling System	Hava Air	Hava Air	Hava Air	Hava Air	Hava Air
İklim Sınıfı Climate Class	T	T	T	T	T
Soğutucu Gaz Refrigerant Gas	R134a	R134a	R134a	R134a	R134a
Ürün Ağırlığı (kg) Product Weight (kg)	26	38	45	75	85
Ürün Ölçüleri (e*d*y) Product Dimension (w*d*h)	355x435x590	500x580x690	500x580x800	738x600x822	738x600x822
Ambalajlı Ölçüler (e*d*y) Packing Dimension (w*d*h)	415x495x765	555x635x855	555x635x965	800x660x1000	800x660x1000
Yükleme Kapasitesi (20DC) Loading Quantities (20DC)	210	72	72	46	46
Yükleme Kapasitesi (40HC) Loading Quantities (40HC)	420	216	144	102	102
Yükleme Kapasitesi (Truck-Optima) Loading Quantities (Truck-Optima)	480	279	186	120	120
Birim Fiyat Unit Price	1150 €	1500 €	1750 €	2350 €	2700 €

**Fiyatlarımıza, ÖTV dahil değildir.

Opsiyonel Parçalar Optional Part

Kapı (Tezgah Tipi) | Door (Counter Type)



100€



110€

Kapı (Dik Tip) | Door (Vertical Type)



180€



200€

Çekmece (Tezgah Tipi)
Drawer (Counter Type)



130€

Çekmece (Cihaz Altı)
Drawer (Under Device)



115€



Conta (Tezgah Tipi) | Gasget (Counter Type) 20€

Conta (Dik Tip) | Gasget (Vertical Type) 25€

Raf (Dik Tip) | Shelf (Vertical Type)

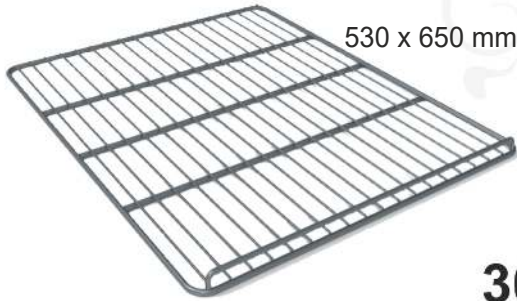

530 x 650 mm

30€

Raf (Tezgah Tipi) | Shelf (Counter Type)

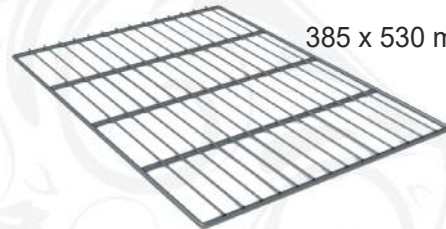

385 x 530 mm

25€

60 Hz Kompresör | 60 Hz Condensing Unit



Fiyat İsteyiniz | Request for Price

Tekerlek | Wheels



25€

**Fiyatlarımıza, ÖTV dahil değildir.



gastrolley

gastrolley



2020

gastrolley

Hakkımızda

GASTROLLEY markamızla taşıma ve servis ekipmanları alanında yenilikçi bir çözüm sunuyoruz. Uzun AR-GE çalışmaları sonucunda ortaya çıkan modüler, dayanıklı, hafif ve sessiz yapısı sayesinde ürünlerimiz benzerlerinden ayrışırken modern tasarımı ve ekonomik olması ile de rekabeti üst seviyeye çıkarıyor...

Kalite uygunluk sertifikalarımız, hızlı ve esnek üretim kabiliyetimiz ihracat pazarlarındaki beklentileri karşılayabilmemize imkan sağlıyor...

About Us

We offer an innovative solution in the field of transportation and service equipment with our GASTROLLEY brand. Modular, durable, light and silent structure of our products, emerged as a result of long R&D studies, distinguishes from their counterparts while attracting competition with their modern design and economy...

Our quality conformity certificates and fast and flexible production capability enable us to meet the expectations in export markets...





Tepsi Taşıma Arabaları (Tekli/75)

Tray Trolleys (Single/75)

Temel Özellikler

Gövde : Alüminyum (Elektrostatik Boyalı) + ABS Kapamalar
Raf : 7 Adet
Raf Aralığı : 9,8 cm
Raf Materyali : ABS
Tekerlekler : 2 Frenli / 2 Frensiz
Tekerlek Tipi : Medikal
Tepsi Ölçüleri : 27x36 , 32x44 , 32x57 , 36x46 , 37x53 cm

Basic Features

Body : Aluminium (Electrostatic Painted) + ABS Surrounded
Shelf : 7 Pcs.
Shelf Space : 9,8 cm
Shelf Material : ABS
Wheels : 2 With Brake / 2 Without Brake
Wheel Type : Medical
Tray Sizes : 27x36 , 32x44 , 32x57 , 36x46 , 37x53 cm



G.ST.75.S.1



G.ST.75.S.2



G.ST.75.S.3



G.ST.75.S.4

Teknik Özellikler | Technical Features

Ürün Kodu Product Code	Ürün Adı Product Name	Ebat (cm) Dimensions (cm)	Ağırlık Net(Kg.) Weight Net (Kg.)	Ağırlık Brüt (Kg.) Weight Gross(Kg.)	Hacim (m ³) Volume (m ³)	Fiyat Price
G.ST.75.S.1	Tekli Servis Tepsi Arabası 75 (Etrafı Açık) Single Service Tray Trolley 75 (Open)	57x71x99	13,50	14,75	0,40	130 €
G.ST.75.S.2	Tekli Servis Tepsi Arabası 75 (2 Yanı Kapalı) Single Service Tray Trolley 75 (2 Sides Closed)	57x71x99	16,50	17,75	0,40	145 €
G.ST.75.S.3	Tekli Servis Tepsi Arabası 75 (2 Yanı + Arka Kapalı) Single Service Tray Trolley 75 (2 Sides + Back Closed)	57x71x99	17,25	18,50	0,40	160 €
G.ST.75.S.4	Tekli Servis Tepsi Arabası 75 (2 Yanı + Arka Kapalı + Kapılı) Single Service Tray Trolley 75 (2 Sides + Back Closed + Door)	57x75x99	22,50	23,00	0,42	215 €

Tepsi Taşıma Arabaları (İkili/75)

Tray Trolleys (Double/75)

Temel Özellikler

Gövde : Alüminyum (Elektrostatik Boyalı) + ABS Kapamalar
Raf : 7 + 7=14 Adet
Raf Aralığı : 9,8 cm
Raf Materyali : ABS
Tekerlekler : 4 Frenli / 2 Frensiz
Tekerlek Tipi : Medikal
Tepsi Ölçüleri : 27x36 , 32x44 , 32x57 , 36x46 , 37x53 cm

Basic Features

Body : Aluminium (Electrostatic Painted) + ABS Surrounded
Shelf : 7 + 7=14 Pcs.
Shelf Space : 9,8 cm
Shelf Material : ABS
Wheels : 4 With Brake / 2 Without Brake
Wheel Type : Medical
Tray Sizes : 27x36 , 32x44 , 32x57 , 36x46 , 37x53 cm



G.ST.75.D.1



G.ST.75.D.2



G.ST.75.D.3



G.ST.75.D.4

Teknik Özellikler | Technical Features

Ürün Kodu Product Code	Ürün Adı Product Name	Ebat (cm) Dimensions (cm)	Ağırlık Net(Kg.) Weight Net (Kg.)	Ağırlık Brüt (Kg.) Weight Gross(Kg.)	Hacim (m ³) Volume (m ³)	Fiyat Price
G.ST.75.D.1	İkili Servis Tepsi Arabası 75 (Etrafı Açık) Double Service Tray Trolley 75 (Open)	101x71x99	23,25	25,00	0,71	210 €
G.ST.75.D.2	İkili Servis Tepsi Arabası 75 (2 Yanı Kapalı) Double Service Tray Trolley 75 (2 Sides Closed)	101x71x99	26,00	27,75	0,71	240 €
G.ST.75.D.3	İkili Servis Tepsi Arabası 75 (2 Yanı Kapalı + Arka Kapalı) Double Service Tray Trolley 75 (2 Sides + Back Closed)	101x71x99	28,00	29,75	0,71	265 €
G.ST.75.D.4	İkili Servis Tepsi Arabası 75 (2 Yanı Kapalı + Arka Kapalı + Kapılı) Double Service Tray Trolley 75 (2 Sides + Back Closed + Door)	101x75x99	35,50	37,25	0,75	375 €



Tepsi Taşıma Arabaları (Tekli/150)

Tray Trolleys (Single/150)

Temel Özellikler

Gövde : Alüminyum (Elektrostatik Boyalı) + ABS Kapamalar
Raf : 15 Adet
Raf Aralığı : 9,8 cm
Raf Materyali : ABS
Tekerlekler : 2 Frenli / 2 Frensiz
Tekerlek Tipi : Medikal
Tepsi Ölçüleri : 27x36 , 32x44 , 32x57 , 36x46 , 37x53 cm

Basic Features

Body : Aluminium (Electrostatic Painted) + ABS Surrounded
Shelf : 15 Pcs.
Shelf Space : 9,8 cm
Shelf Material : ABS
Wheels : 2 With Brake / 2 Without Brake
Wheel Type : Medical
Tray Sizes : 27x36 , 32x44 , 32x57 , 36x46 , 37x53 cm



G.ST.150.S.1



G.ST.150.S.2



G.ST.150.S.3



G.ST.150.S.4

Teknik Özellikler | Technical Features

Ürün Kodu Product Code	Ürün Adı Product Name	Ebat (cm) Dimensions (cm)	Ağırlık Net(Kg.) Weight Net (Kg.)	Ağırlık Brüt (Kg.) Weight Gross(Kg.)	Hacim (m ³) Volume (m ³)	Fiyat Price
G.ST.150.S.1	Tekli Servis Tepsi Arabası 150 (Etrafı Açık) Single Service Tray Trolley 150 (Open)	57x71x174	17,25	19,50	0,70	170 €
G.ST.150.S.2	Tekli Servis Tepsi Arabası 150 (2 Yanı Kapalı) Single Service Tray Trolley 150 (2 Sides Closed)	57x71x174	22,75	25,00	0,70	200 €
G.ST.150.S.3	Tekli Servis Tepsi Arabası 150 (2 Yanı + Arka Kapalı) Single Service Tray Trolley 150 (2 Sides + Back Closed)	57x71x174	25,25	27,50	0,70	230 €
G.ST.150.S.4	Tekli Servis Tepsi Arabası 150 (2 Yanı + Arka Kapalı + Kapılı) Single Service Tray Trolley 150 (2 Sides + Back Closed + Door)	57x75x174	32,50	34,75	0,74	340 €

Tepsi Taşıma Arabaları (İkili/150)

Tray Trolleys (Double/150)

Temel Özellikler

Gövde : Alüminyum (Elektrostatik Boyalı) + ABS Kapamalar
Raf : 15 + 15=30 Adet
Raf Aralığı : 9,8 cm
Raf Materyali : ABS
Tekerlekler : 4 Frenli / 2 Frensiz
Tekerlek Tipi : Medikal
Tepsi Ölçüleri : 27x36 , 32x44 , 32x57 , 36x46 , 37x53 cm

Basic Features

Body : Aluminium (Electrostatic Painted) + ABS Surrounded
Shelf : 15 + 15=30 Pcs.
Shelf Space : 9,8 cm
Shelf Material : ABS
Wheels : 4 With Brake / 2 Without Brake
Wheel Type : Medical
Tray Sizes : 27x36 , 32x44 , 32x57 , 36x46 , 37x53 cm



G.ST.150.D.1

G.ST.150.D.2

G.ST.150.D.3

G.ST.150.D.4

Teknik Özellikler | Technical Features

Ürün Kodu Product Code	Ürün Adı Product Name	Ebat (cm) Dimensions (cm)	Ağırlık Net(Kg.) Weight Net (Kg.)	Ağırlık Brüt (Kg.) Weight Gross(Kg.)	Hacim (m ³) Volume (m ³)	Fiyat Price
G.ST.150.D.1	İkili Servis Tepsi Arabası 150 (Etrafı Açık) Double Service Tray Trolley 150 (Open)	101x71x174	32,25	35,00	1,25	280 €
G.ST.150.D.2	İkili Servis Tepsi Arabası 150 (2 Yanı Kapalı) Double Service Tray Trolley 150 (2 Sides Closed)	101x71x174	37,75	40,50	1,25	325 €
G.ST.150.D.3	İkili Servis Tepsi Arabası 150 (2 Yanı Kapalı + Arka Kapalı) Double Service Tray Trolley 150 (2 Sides + Back Closed)	101x71x174	41,25	44,00	1,25	395 €
G.ST.150.D.4	İkili Servis Tepsi Arabası 150 (2 Yanı Kapalı + Arka Kapalı + Kapılı) Double Service Tray Trolley 150 (2 Sides + Back Closed + Door)	101x75x174	54,25	57,00	1,32	600 €



Küvet Taşıma Arabaları (75)

Gastronorm Pan Trolleys (75)

Temel Özellikler

Gövde : Alüminyum (Elektrostatik Boyalı) + PP Kapamalar
Raf : 15 / 15 + 15 = 30 Adet
Raf Aralığı : 5 cm
Raf Materyali : PC
Tekerlekler : 2 Frenli , 2 Frensiz / 4 Frenli , 2 Frensiz
Tekerlek Tipi : Medikal
Küvet Ölçüleri : GN 1/1 , GN 1/2 , GN 1/3

Basic Features

Body : Aluminium (Electrostatic Painted) + PP Surrounded
Shelf : 15 / 15 + 15 = 30 Pcs.
Shelf Space : 5 cm
Shelf Material : PC
Wheels : 2 With Brake, 2 Without Brake/4 With Brake, 2 Without Brake
Wheel Type : Medical
Pan Size : GN 1/1 , GN 1/2 , GN 1/3



G.GN.75.S.1



G.GN.75.D.1

Teknik Özellikler | Technical Features

Ürün Kodu Product Code	Ürün Adı Product Name	Ebat (cm) Dimensions (cm)	Ağırlık Net(Kg.) Weight Net (Kg.)	Ağırlık Brüt (Kg.) Weight Gross(Kg.)	Hacim (m ³) Volume (m ³)	Fiyat Price
G.GN.75.S.1	Tekli Gn Küvet Taşıma Arabası 75 (Etrafı Açık) Single Self SerSingle Gastronorm Pan Trolley 75 (Open)	53x71x99	13,25	14,50	0,37	155 €
G.GN.75.S.2	Tekli Gn Küvet Taşıma Arabası 75 (2 Yanı Kapalı) Single Gastronorm Pan Trolley 75 (2 Sides Closed)	53x71x99	15,50	16,75	0,37	165 €
G.GN.75.D.1	İkili Gn Küvet Taşıma Arabası 75 (Etrafı Açık) Double Gastronorm Pan Trolley 75 (Open)	93x71x99	22,50	24,25	0,65	270 €
G.GN.75.D.2	İkili Gn Küvet Taşıma Arabası 75 (2 Yanı Kapalı) Double Gastronorm Pan Trolley 75 (2 Sides Closed)	93x71x99	24,75	26,50	0,65	280 €

Küvet Taşıma Arabaları (150)

Gastronorm Pan Trolleys (150)

Temel Özellikler

Gövde : Alüminyum (Elektrostatik Boyalı) + PP Kapamalar
Raf : 30 / 30 + 30 = 60 Adet
Raf Aralığı : 5 cm
Raf Materyali : PC
Tekerlekler : 2 Frenli , 2 Frensiz / 4 Frenli , 2 Frensiz
Tekerlek Tipi : Medikal
Küvet Ölçüleri : GN 1/1 , GN 1/2 , GN 1/3

Basic Features

Body : Aluminium (Electrostatic Painted) + PPSurrounded
Shelf : 30 / 30 + 30 = 60 Pcs.
Shelf Space : 5 cm
Shelf Material : PC
Wheels : 2 With Brake, 2 Without Brake/4 With Brake, 2 Without Brake
Wheel Type : Medical
Pan Sizes : GN 1/1 , GN 1/2 , GN 1/3



G.GN.150.S.1



G.GN.150.D.1

Teknik Özellikler | Technical Features

Ürün Kodu Product Code	Ürün Adı Product Name	Ebat (cm) Dimensions (cm)	Ağırlık Net(Kg.) Weight Net (Kg.)	Ağırlık Brüt (Kg.) Weight Gross(Kg.)	Hacim (m ³) Volume (m ³)	Fiyat Price
G.GN.150.S.1	Tekli Gn Küvet Taşıma Arabası 150 (Etrafı Açık) Single Gastronorm Pan Trolley 150 (Open)	53x71x174	19,00	21,25	0,65	210 €
G.GN.150.S.2	Tekli Gn Küvet Taşıma Arabası 150 (2 Yanı Kapalı) Single Gastronorm Pan Trolley 150 (2 Sides Closed)	53x71x174	23,50	25,75	0,65	230 €
G.GN.150.D.1	İkili Gn Küvet Taşıma Arabası 150 (Etrafı Açık) Double Gastronorm Pan Trolley 150 (Open)	93x71x174	31,75	34,50	1,15	375 €
G.GN.150.D.2	İkili Gn Küvet Taşıma Arabası 150 (2 Yanı Kapalı) Double Gastronorm Pan Trolley 150 (2 Sides Closed)	93x71x174	36,25	39,00	1,15	395 €



Hastane Sıcak Servis Arabaları & Ekipmanlar

Hospital Hot Service Trolleys & Equipments

Temel Özellikler

Dış Gövde : Alüminyum (Elektrostatik Boyalı) + ABS Kapamalar
İç Gövde : Alüminyum (Elektrostatik Boyalı) + PC Kapamalar
Raf : 12 + 2 = 14 / 24 + 4 = 28 Adet
Raf Aralığı : 7,5 cm
Raf Materyali : PC
Isıtma Aralığı : +65 ~ 90°C
Gösterge : Dijital Termometre
Voltaj / Frekans : 220-230 V / 50-60Hz
Güç : 1200 W
İzolasyon : Tüm Yüzeyler
Tekerlekler : 4 Frenli
Tekerlek Tipi : Medikal
Tepsi Ölçüleri : 36x46 , 37x53
Isı Kontrolü - Emniyet Şalteri : Evet

Basic Features

Outside Body : Aluminium (Electrostatic Painted) + ABS Surrounded
Inside Body : Aluminium (Electrostatic Painted) +PC Surrounded
Shelf : 12 + 2 = 14 / 24 + 4 = 28 Pcs.
Shelf Space : 7,5 cm
Shelf Material : PC
Heating Range: +65 ~ 90°C
Display : Digital Thermometer
Voltage/Freq. : 220-230 V / 50-60Hz
Power : 1200 W
Isolation : All Sides
Wheels : 4 With Brake
Wheel Type : Medical
Tray Sizes : 36x46 , 37x53
Temp. Control -Safety Switch : Yes



G.MD.100.25.S



G.MD.100.25.D

Teknik Özellikler | Technical Features

Ürün Kodu Product Code	Ürün Adı Product Name	Ebat (cm) Dimensions (cm)	Ağırlık Net(Kg.) Weight Net (Kg.)	Ağırlık Brüt (Kg.) Weight Gross(Kg.)	Hacim (m ³) Volume (m ³)	Fiyat Price
G.MD.100.25.S	Tekli Hastane Tepsi Arabası 100 / 25 (Isıtmalı+Nötr) Single Hospital Tray Trolley 100 / 25 (Heated+Neutral)	57x79x158	59,00	84,00	0,71	1400 €
G.MD.100.25.D	İkili Hastane Tepsi Arabası 100 / 25 (Isıtmalı+Nötr) Double Hospital Tray Trolley 100 / 25 (Heated+Neutral)	101x79x158	92,00	125,00	1,26	2100 €

Banket Arabaları

Banquet Trolleys

Temel Özellikler

Dış Gövde	: Alüminyum (Elektrostatik Boyalı) +ABS Kapamalar
İç Gövde	: Alüminyum (Elektrostatik Boyalı) + PC Kapamalar
Raf	: 15 / 20 / 30 / 15 + 10 = 25 Adet
Raf Aralığı	: 5 cm
Raf Materyali	: PC
Isıtma Aralığı	: +65 ~ 90°C
Soğutma Aralığı	: 0 ~ +4°C
Gösterge	: Dijital Termometre
Voltaj / Frekans	: 220-230 V / 50-60Hz
Güç	: 1075 W / 1200 W / 1300 W / 1075 W
İzolasyon	: Tüm Yüzeyler
Tekerlekler	: 4 Frenli
Tekerlek Tipi	: Medikal
Küvet Ölçüleri	: GN 1/1 , GN 1/2 , GN 1/3
Isı Kontrolü - Emniyet Şalteri	: <u>Evet</u>

Basic Features

Outside Body	: Aluminium (Electrostatic Painted) + ABS Surrounded
Inside Body	: Aluminium (Electrostatic Painted) + PC Surrounded
Shelf	: 15 / 20 / 30 / 15 + 10 = 25 Pcs.
Shelf Space	: 5 cm
Shelf Material	: PC
Heating Range	: +65 ~ 90°C
Cooling Range	: 0 ~ +4°C
Display	: Digital Thermometer
Voltage/Freq.	: 220-230 V / 50-60Hz
Power	: 1075 W / 1200 W / 1300 W / 1075 W
Isolation	: All Sides
Wheels	: 4 With Brake
Wheel Type	: Medical
Pan Sizes	: GN 1/1 , GN 1/2 , GN 1/3
Temp. Control - Safety Switch	: <u>Yes</u>



G.BQ.75.GN

G.BQ.100.GN

G.BQ.125.GN

G.BQ.75.50.GN

Teknik Özellikler | Technical Features

Ürün Kodu Product Code	Ürün Adı Product Name	Ebat (cm) Dimensions (cm)	Ağırlık Net(Kg.) Weight Net (Kg.)	Ağırlık Brüt (Kg.) Weight Gross(Kg.)	Hacim (m ³) Volume (m ³)	Fiyat Price
G.BQ. 75.GN	Banquet 75 (Isıtmalı) Banquet 75 (Heated)	57x79x99	39,00	54,00	0,45	650 €
G.BQ.100.GN	Banquet 100 (Isıtmalı) Banquet 100 (Heated)	57x79x124	48,00	68,00	0,56	720 €
G.BQ.125.GN	Banquet 125 (Isıtmalı) Banquet 125 (Heated)	57x79x149	57,00	82,00	0,67	800 €
G.BQ.75.50.GN	Banquet 75 / 50 (Isıtmalı + Soğutmalı) Banquet 75 / 50 (Heated + Frigoriflic)	57x79x192	66,00	96,00	0,86	1200 €



TermoKabin

ThermoCabin

Temel Özellikler

Dış Gövde : Alüminyum (Elektrostatik Boyalı) + PP Kapamalar
İç Gövde : Alüminyum (Elektrostatik Boyalı) + PP Kapamalar
Raf : 15 / 20 / 30 Adet
Raf Aralığı : 5 cm
Raf Materyali : PC
İzolasyon : Tüm Yüzeyler
Tekerlekler : 4 Frenli
Tekerlek Tipi : Medikal
Küvet Ölçüleri: GN 1/1 , GN 1/2 , GN 1/3

Basic Features

Outside Body : Aluminium (Electrostatic Painted) + PP Surrounded
Inside Body : Aluminium (Electrostatic Painted) + PP Surrounded
Shelf : 15 / 20 / 30 Pcs.
Shelf Space : 5 cm
Shelf Material : PC
Isolation : All Sides
Wheels : 4 With Brake
Wheel Type : Medical
Pan Sizes : GN 1/1 , GN 1/2 , GN 1/3



G.TC.75.GN



G.TC.100.GN



G.TC.125.GN

Teknik Özellikler | Technical Features

Ürün Kodu Product Code	Ürün Adı Product Name	Ebat (cm) Dimensions (cm)	Ağırlık Net(Kg.) Weight Net (Kg.)	Ağırlık Brüt (Kg.) Weight Gross(Kg.)	Hacim (m ³) Volume (m ³)	Fiyat Price
G.TC.75.GN	ThermoCabin 75	53x78x99	26,75	30,00	0,41	250 €
G.TC.100.GN	ThermoCabin 100	53x78x124	31,75	35,50	0,51	300 €
G.TC.125.GN	ThermoCabin 125	53x78x149	37,00	41,25	0,62	350 €

Termo Tepsi Taşıma Arabaları

Thermo Tray Trolleys

Temel Özellikler

Gövde : Alüminyum (Elektrostatik Boyalı) + ABS Kapamalar
Raf : 9 / 9 + 9 = 18 Adet
Raf Aralığı : 13,8 cm
Raf Materyali : ABS
Tekerlekler : 2 Frenli , 2 Frensiz / 4 Frenli , 2 Frensiz
Tekerlek Tipi : Medikal
Tepsi Ölçüleri : 37x53 , 38x54 cm

Basic Features

Body : Aluminium (Electrostatic Painted) + ABS Surrounded
Shelf : 9 / 9 + 9 = 18 Pcs.
Shelf Space : 13,8 cm
Shelf Material : ABS
Wheels : 2 With Brake , 2 Without Brake / 4 With Brake , 2 Without Brake
Wheel Type : Medical
Tray Sizes : 37x53 , 38x54 cm



G.TT.09.S.2



G.TT.18.D.2

Teknik Özellikler | Technical Features

Ürün Kodu Product Code	Ürün Adı Product Name	Ebat (cm) Dimensions (cm)	Ağırlık Net(Kg.) Weight Net (Kg.)	Ağırlık Brüt (Kg.) Weight Gross(Kg.)	Hacim (m ³) Volume (m ³)	Fiyat Price	
G.TT.09.S.1	Tekli Termo Tepsi Arabası Single Thermo Tray Trolley	9 (Etrafı Açık) 9 (Open)	57x71x149	15,75	17,25	0,60	155 €
G.TT.09.S.2	Tekli Termo Tepsi Arabası Single Thermo Tray Trolley	9 (2 Yanı Kapalı) 9 (2 Sides Closed)	57x71x149	20,50	22,00	0,60	185 €
G.TT.18.D.1	İkili Termo Tepsi Arabası Double Thermo Tray Trolley	9 + 9 (Etrafı Açık) 9 + 9 (Open)	101x71x149	28,50	31,00	1,07	250 €
G.TT.18.D.2	İkili Termo Tepsi Arabası Double Thermo Tray Trolley	9 + 9 (2 Yanı Kapalı) 9 + 9 (2 Sides Closed)	101x71x149	33,25	35,75	1,07	280 €



Self Servis Taşıma Arabaları & Servis Ekipmanları

Self Service Tray Trolleys & Service Equipments

Temel Özellikler

Gövde : Alüminyum (Elektrostatik Boyalı) + PP Kapamalar
Raf : 29 / 29 + 29 = 58 Adet
Raf Aralığı : 5 cm
Raf Materyali : PC
Tekerlekler : 2 Frenli , 2 Frensiz / 4 Frenli , 2 Frensiz
Tekerlek Tipi : Medikal
Self Servis Ölçüleri: 39.8 x 27.9 x 2.8 cm
Self Servis Kapasite: 58 / 58 x 2 = 116 Adet

Basic Features

Body : Aluminium (Electrostatic Painted) + PP Surrounded
Shelf : 29 / 29 + 29 = 58 Pcs.
Shelf Space : 5 cm
Shelf Material : PC
Wheels : 2 With Brake, 2 Without Brake/4 With Brake, 2 Without Brake
Wheel Type : Medical
Table d'hote Size: 39.8 x 27.9 x 2.8 cm
Table d'hote Cpty: 58 / 58 x 2 = 116 Pcs.



G.SS.150.S.1



G.ST.3753



G.STK.3753



G.HSL.11



G.PCS.01

Teknik Özellikler | Technical Features

Ürün Kodu Product Code	Ürün Adı Product Name	Ebat (cm) Dimensions (cm)	Ağırlık Net(Kg.) Weight Net (Kg.)	Ağırlık Brüt (Kg.) Weight Gross(Kg.)	Hacim (m ³) Volume (m ³)	Fiyat Price
G.SS.150.S.1	Tekli Self Servis Arabası 150 (Etrafı Açık) Single Self Service Trolley 150 (Open)	59x71x174	19,00	21,25	0,73	210 €
G.SS.150.S.2	Tekli Self Servis Arabası 150 (2 Yanı Kapalı) Single Self Service Trolley 150 (2 Sides Closed)	59x71x174	24,50	26,75	0,73	230 €
G.SS.150.D.1	İkili Self Servis Arabası 150 (Etrafı Açık) Double Self Service Trolley 150 (Open)	104x71x174	31,75	34,50	1,28	375 €
G.SS.150.D.2	İkili Self Servis Arabası 150 (2 Yanı Kapalı) Double Self Service Trolley 150 (2 Sides Closed)	104x71x174	37,25	40,00	1,28	395 €

Ürün Kodu Product Code	Ürün Adı Product Name	Ebat (cm) Dimensions (cm)	Koli İçi Adet Pieces in Box	Koli Net(Kg.) Box Net (Kg.)	Koli Brüt (Kg.) Box Gross(Kg.)	Hacim (m ³) Volume (m ³)	Fiyat Price
G.HSL.11	Sızdırmaz Contalı Kapak (GN 1/1 Uyumlu) Sealed Cover (Suitable for GN 1/1)	32,5x53	10	10,17	10,82	0,049	20 €
G.PCS.01	PC Self Servis PC Table d'hote	39,8x27,9x2,8	20	7,1	7,42	0,013	2,5 €
G.ST.3753	ABS Servis Tepsisi ABS Service Tray	37x53	20	11,71	12,25	0,027	4 €
G.STK.3753	ABS Kırçilli Servis Tepsisi ABS Flecked Service Tray	37x53	20	16	16,5	0,027	4,5 €



PiMAK

Çamaşırhane & Bulaşikhane

Laundry & Scullery

Çamaşır Kurutma Makinası

Tumble Drying Machine

Temel Özellikler

- Kırışmayı, sertleşmeyi ve ısı şokunu engelleyen 'Cool Down' soğutma sistemi mevcuttur.
- Tamburun çift yöne dönüş özelliği sayesinde daha kısa sürede çamaşırların kurutulması sağlanır.
- Gövde izolasyonu ile ortama olan ısı kayıplarının önlenmesi sağlanmıştır.
- Preste imal edilmiş camlı gözetleme kapağında hava sızdırma önleyici özel yapım conta mevcuttur.

Basic Features

- There is a "cool down" cooling system which prevents wrinkling, hardening and heat shock.
- Thanks to the double direction rotation feature of the drum, it is ensured that the laundry dry in a shorter time.
- By the body insulation, the prevention of heat losses is ensured.
- There is an air leak prevention, custom-made gasket in the glazed inspection cover which is made by a pressing machine.



Teknik Özellikler | Technical Features

Ürün Kodu Product code	ÖÇKME 4.3.20	ÖÇKME 4.3.30	ÖÇKME 4.3.40	ÖÇKME 4.3.50	ÖÇKME 4.3.60
Kapasite Capacity	20 kg	30 kg	40 kg	50 kg	60 kg
Tambur Çapı Drum Diameter	1145 mm	1145 mm	1145 mm	1145 mm	1145 mm
Tambur Derinliği Drum Depth	450 mm	670 mm	780 mm	980 mm	910 mm
Tambur Hacmi Drum Volume	463 lt	689 lt	802 lt	1008 lt	1207 lt
Tambur Motor Gücü Drum Motor Power	0,75 kw 1500 dv/dk	0,75 kw 1500 dv/dk	0,75 kw 1500 dv/dk	0,75 kw 1500 dv/dk	0,75 kw 1500 dv/dk
Fan Motor Gücü Fan Motor Power	0,75 kw 3000 dv/dk	0,75 kw 3000 dv/dk	0,75 kw 3000 dv/dk	0,75 kw 3000 dv/dk	0,75 kw 3000 dv/dk
Isıtma Gücü Heating Power	18 kw	18 kw	22,5 kw	27 kw	27 kw
Isıtma Tipi Heating Type	Elektrik	Elektrik	Elektrik	Elektrik	Elektrik
Kablo Kesiti* Cable cross section*	4x6 mm ²	4x6 mm ²	4x10 mm ²	4x10 mm ²	4x10 mm ²
Ebat Dimensions	1400x800x800 mm	1400x1050x800 mm	1400x1160x800 mm	1400x1350x800 mm	1400x1300x800 mm
Ağırlık Weight	341 kg	390 kg	440 kg	510 kg	550 kg
Fiyat Price	5000 €	5500 €	6200 €	7500 €	11.250 €

Çamaşır Yıkama & Sıkma Makinası

Laundry Washing & Spinning Machine

Temel Özellikler

- İç – dış tamburu, camlı gözetleme kapağı, menteşe kilit sistemi ve dış kaplama panelleri AISI 304 Kalite 18/8 CR-Nİ paslanmaz çelikten imal edilmiştir.
- Makine kapağında sızdırma önleyici, özel yapım conta mevcuttur. Ayrıca kapak kilit sistemi sayesinde makinenin kapağı açık olduğu takdirde çalışmaması ve çalışır durumda olan makinenin kapağının açılmaması sağlanmaktadır.
- Makina, ön panel üzerine monte edilmiş elektronik dijital göstergeli kumanda ile kontrol edilir. Cihazda 25 sabit program bulunmakla birlikte, sınırsız sayıda isteğe özel program seçenekleri, deterjan, elektrik, su ve zamandan tasarruf sağlamaktadır.
- Çalışma sırasında herhangi öngörülemeyen bir nedenden kaynaklı olarak meydana gelebilecek sarsıntı dolayısıyla zarar oluşmasını engellemek amacıyla, makinenin otomatik olarak durmasını sağlayan güvenlik sistemi mevcuttur.
- Geliştirilmiş yay, amortisör ve kasnak sistemi sayesinde, minimum titreşim ve balans sağlamaktadır.

Basic Features

- The inner and outer drum, glazed inspection cover and outer cover panels, are made of AISI 304 Quality 18/8 CR-NI stainless steel.
- There is a leak prevention, custom-made gasket in the machine door. Further, it's ensured that the machine doesn't work when its door is open, and the door of a working machine won't open due to the door locking system.
- The machine is controlled by an electronic digital display mounted on the front control panel. Although there are 25 fixed programs on the machine, it provides unlimited optional programs and electricity, water and time saving.
- There is a safety system which makes the machine stop automatically, for the purpose of preventing damage because of a vibration that could occur, arising from an unforeseen cause during operation.
- It provides minimum vibration and balance, thanks to the improved spring, damper and pulley system.



Teknik Özellikler | Technical Features

Ürün Kodu Product code	ÖÇYSME 4.1.20	ÖÇYSME 4.1.30	ÖÇYSME 4.1.40	ÖÇYSME 4.1.50	ÖÇYSME 4.1.60
Kapasite Capacity	20 kg	30 kg	40 kg	50 kg	60 kg
Tambur Çapı Drum Diameter	700 mm	800 mm	900 mm	995 mm	995 mm
Tambur Derinliği Drum Depth	550 mm	610 mm	635 mm	650 mm	780 mm
Tambur Hacmi Drum Volume	211 Lt	306 Lt	403Lt	505 Lt	606 Lt
Motor Gücü Motor Power	3 kw	4 kw	5,5 kw	7,5 kw	7,5 kw
Isıtma Gücü Heating Power	13,5 kw	18 kw	22,5 kw	27 kw	36 kw
Isıtma Tipi Heating Type	Elektrik	Elektrik	Elektrik	Elektrik	Elektrik
Kablo Kesiti* Cable cross section*	4x6 mm ²	4x6 mm ²	4x10 mm ²	4x10 mm ²	4x10 mm ²
Su Girişi Water Input	3/4 "	3/4 "	3/4 "	3/4 "	3/4 "
Ebat Dimensions	1100x1335x1350 mm	1200x1350x1480 mm	1310x1400x1710 mm	1390x1430x1800 mm	1390x1530x1800 mm
Ağırlık Weight	613 kg	757 kg	938 kg	1120 kg	1210 kg
Fiyat Price	8000 €	8500 €	10.000 €	14.500 €	17.000 €

*Kablo kesiti minimum oranda belirtilmiştir. Kablo uzunluğuna göre kesitlerin artırılması gerekmektedir.

*Cable cross section is specified in minimum ratio. Cross sections should be increased according to the cable length.

Bantlı Silindir Ütü Makinası

Flatwork Ironing Machine

Temel Özellikler

- Dış kaplamalar elektrostatik toz boyalı DKP sac malzemeden imal edilmiştir.
- Hız ayarı mevcuttur.
- Elektrik kesintilerinde çamaşırı makineden çıkarmak için manuel işletme kolu bulunmaktadır.
- Kilit sistemi sayesinde makinenin kapakları açık iken çalışmaması sağlanmaktadır.
- Sessiz ve kolay kullanımı öne çıkaran çalışma sistemi mevcuttur.
- Kablo kesiti minimum oranda belirtilmiştir. Kablo uzunluğuna göre kesitin artırılması gerekmektedir.

Basic Features

- Outer coverings are made of electrostatic powder coated DKP sheet material.
- Speed adjustment is available.
- There is a manual operating lever to remove the laundry from the machine in case of power cuts.
- Thanks to the lock system, the machine is ensured not to operate while the covers are open.
- There is a working system that emphasizes silent and easy use.
- Cable cross section is specified in minimum ratio. The cross section should be increased according to the cable length.



Teknik Özellikler | Technical Features

Ürün Kodu Product code	ÖBÜME 4.4.4	ÖBÜME 4.4.9
Silindir Boyu (mm) Cylinder Length (mm)	1800	2000
Silindir Çapı (mm) Cylinder Diameter (mm)	600	600
Motor Gücü (kw) Motor power (kw)	0,75	0,75
Isıtma Gücü (kw) Heating Power (kw)	22,5	22,5
Isıtma Tipi Heating Type	Elektrik / Electric	Elektrik
Kablo Kesiti (mm2) Cable cross section (mm2)	4x10	4x10
Genişlik (mm2) Width (mm2)	22410	22610
Derinlik (mm) Depth (mm2)	1160	1160
Yükseklik (mm) Height (mm2)	1150	1150
Ağırlık (kg) Weight (kg)	825	841 kg
Fiyat € Price €	9500 €	10.500 €

Pres Ütü & Kendinden Kazanlı Paskala Ütü Makinası

Press Ironing Machine & Narrow Ironing Table Within Boiler

Pres Ütü Temel Özellikler

- Üst ütüleme çenesi alüminyum dökümden imal edilmiş olup, buhar eşit şekilde dağılmaktadır.
- Özel olarak imal edilen buhar ventilleri sayesinde yüksek ısı, kuru buhar kullanarak istenilen formda ütüleme imkânı sağlamaktadır.
- Baskı ayarlıdır.
- Üst çenenin alt yastığı kilitlenmesine ve açılmasına, buhar vermeye yarayan ayaklı kumanda pedalları mevcuttur.

Press Iron Basic Features

- The top ironing jaw is made of cast aluminum and steam is distributed evenly.
- Thanks to specially manufactured steam valves, it provides the opportunity to iron in desired form by using high-temperature, dry steam.
- Print is set.
- There are foot control pedals for locking and unlocking the lower cushion of the upper jaw and giving steam.

Pres Ütü Temel Özellikler

- Ergonomik tasarımı ve tekerlekli arka ayakları makinanın taşınması ve yerleştirilmesinde kolaylık sağlamaktadır.
- Kısa sürede (8 dakika) buharı hazır hale gelir ve
- Tabla ısı, termostat ile ayarlanmaktadır ve uzun sürelerle kesintisiz ütü yapma olanağı sunar.
- İçerdiği su deposundan otomatik olarak su aktarımı yapmaktadır.
- Kombine sistemi sayesinde ilave bir buhar jeneratörü gerektirmez.

Press Iron Basic Features

- Ergonomic design and wheeled legs provide convenience in the transportation and placement of the machine.
- Steam is ready in a short time (8 minutes) and
- The table temperature is adjusted with a thermostat and offers the possibility of ironing without interruption for a long time.
- It automatically transfers water from the water tank it contains.
- Thanks to its combined system, it does not require an additional steam generator.

Kendinden Kazanlı Paskala Ütü
Narrow Ironing Machine Table within Boiler



Pres Ütü
Press Ironing Machine



Teknik Özellikler | Technical Features

Ürün Kodu Product Code	ÖPÜM 0021
Pompa Gücü (kw) Pump Power (kw)	0,75
Isıtma Gücü (kw) Heating Power (kw)	20
Buhar Basıncı (Bar) Steam Pressure (Bar)	4
Buhar Kapasitesi (kg/h) Steam Capacity (kg / h)	24
Genişlik (mm) Width (mm)	1450
Derinlik (mm) Depth (mm)	1350
Yükseklik (mm) Height (mm)	1450
Ağırlık (kg) Weight (kg)	380
Fiyat € Price €	6950 €

Ürün Kodu Product Code	ÖPÜM 0022
Pompa Gücü (kw) Pump Power (kw)	0,37
Vakum Motoru (kw) Vacuum Motor (kw)	0,37
Isıtma Gücü (kw) Heating Power (kw)	5
Çalışma Basıncı (Bar) Working Pressure (Bar)	3,5
Buhar Kapasitesi (kg/h) Steam Capacity (kg / h)	24
Su Deposu Hacmi (Lt) Water Tank Volume (Lt)	30
Genişlik (mm) Width (mm)	1400
Derinlik (mm) Depth (mm)	500
Yükseklik (mm) Height (mm)	900
Ağırlık (kg) Weight (kg)	85
Fiyat € Price €	2500 €

Set Altı Bardak & Tezgah Altı Bulaşık Yıkama Makinesi

Glass Washer & Cunter-bottom Type Dishwashers

Set Altı Model Temel Özellikler

- Su girişi 3/4"
- Güç kaynağı elektrik
- Kumanda tipi analog
- Yıkama tankı hacmi 17 Lt
- Boyler tankı hacmi 3.6 Lt
- Yıkama sıcaklığı 50-55 °C
- Durulama sıcaklığı 70-75 °C
- Her durulamada 0.6 Lt su harcar
- İç kabin yüksekliği 185 mm
- Yıkama motoru 0,26 kW
- Tank rezistansı gücü 1 kW
- Boyler rezistansı gücü 2 kW
- Net ağırlık 37 Kg

Glass Washer Basic Features

- Water inlet 3/4"
- Power supply is electricity
- Control type is analog
- The volume of wash tank 17 Lt
- The volume of boiler tank 3.6 Lt
- Wash temperature at 50-55 °C
- Rinse temperature at 70-75 °C
- Consumes 0.6 liters of water each rinse
- Internal cabinet height 185 mm
- Wash motor power 0.26 kW
- Tank resistance power is 1 kW
- Boiler resistance power is 2 kW
- Net weight 37 Kg

Tezgah Altı Model Temel Özellikler

- Su girişi 3/4"
- Güç kaynağı elektrik
- Kumanda tipi analog
- Yıkama tankı hacmi 27 Lt
- Boyler tankı hacmi 6.5 Lt
- Yıkama sıcaklığı 50-55 °C
- Durulama sıcaklığı 80-85 °C
- Her durulamada 0.8 Lt su harcar
- İç kabin yüksekliği 340 mm
- Yıkama motoru 0,6 Kw
- Tank rezistansı gücü 2 kW
- Boyler rezistansı gücü 4 kW
- Net ağırlık 60 Kg

Cunter-bottom Type Basic Features

- Water inlet 3/4"
- Power supply is electricity
- Control type is analog
- The volume of wash tank 27 Lt
- The volume of boiler tank 6.5 Lt
- Wash temperature at 50-55 °C
- Rinse temperature at 80-85 °C
- Consumes 0.8 liters of water each rinse
- Internal cabinet height 340 mm
- Wash motor power 0.6 kW
- Tank resistance power is 2 kW
- Boiler resistance power is 2 kW
- Net weight 60 Kg

Set Altı Bardak Yıkama Makinesi

Glass Washer



M038-1

Tezgah Altı Bulaşık Yıkama Makinesi

Tezgah Altı Bulaşık Yıkama Makinesi



M036-B



M036-DS

Teknik Özellikler | Technical Features

Ürün Kodu Product Code	Enerji Tipi Energy Type	Kapasite (Ürün/Saat) Capacity (Item/Hour)	Ebat (cm) Dimensions (cm)	Ağırlık (Kg.) Weight (Kg.)	Fiyat Price
M038-1	⚡	800	45x50x65	-	1230 €
M036-B	⚡	500	60x60x82	60	1370 €
M036-DS		-	-	-	230 €

Giyotin Tipi Bulaşık Yıkama Makinesi

Giotin Type Dishwashers

Temel Özellikler

- Su girişi 3/4"
- Güç kaynağı elektrik
- Kumanda tipi analog
- Yıkama tankı hacmi 45 Lt
- Boyler tankı hacmi 8.6 Lt
- Yıkama sıcaklığı 50-55 °C
- Durulama sıcaklığı 80-85 °C
- Her durulamada 0.9 Lt su harcar
- İç kabin yüksekliği 185 mm
- Yıkama motoru 0,26 kW
- Tank rezistansı gücü 1 kW
- Boyler rezistansı gücü 2 kW
- Net ağırlık 95 Kg

Basic Features

- Water inlet 3/4"
- Power supply is electricity
- Control type is analog
- The volume of wash tank 17 Lt
- The volume of boiler tank 3.6 Lt
- Wash temperature at 50-55 °C
- Rinse temperature at 70-75 °C
- Consumes 0.6 liters of water each rinse
- Internal cabinet height 185 mm
- Wash motor power 0.26 kW
- Tank resistance power is 1 kW
- Boiler resistance power is 2 kW
- Net weight 95 Kg

**M036-1****PMK.TB.03****Teknik Özellikler | Technical Features**

Ürün Kodu Product Code	Enerji Tipi Energy Type	Güç (kW/) Power (kW/)	Kapasite (Tabak/Saat) Capacity (Plate/Hour)	Ebat (cm) Dimensions (cm)	Ağırlık (Kg.) Weight (Kg.)	Fiyat Price
M036-1	⚡	1,5	1000	65x82x140	95	1750 €
PMK.TB.01	-	-	-	-	-	-
PMK.TB.02	-	-	-	-	-	-
PMK.TB.03	-	-	-	-	-	-

**Sepet Fiyatları için, lütfen fiyat talep ediniz. For Basket Prices, please submit your price request.

Konveyörlü Tip Bulaşık Yıkama Makinesi

Conveyor Type Dishwashers

Set Altı Model Temel Özellikler

- Su girişi 3/4"
- Güç kaynağı elektrik
- Kumanda tipi analog
- Yıkama tankı hacmi 50+55
- Boyler tankı hacmi 18 Lt
- Yıkama sıcaklığı 50-55 °C
- Durulama sıcaklığı 80-85 °C
- Her durulamada 0.6 Lt su harcar
- İç kabin yüksekliği 480 mm
- Yıkama motoru 1, 1 x2 kW
- Tank rezistansı gücü 6 kW
- Boyler rezistansı gücü 18 kW
- Net ağırlık 255 Kg

Glass Washer Basic Features

- Water inlet 3/4"
- Power supply is electricity
- Control type is analog
- The volume of wash tank 50+55 Lt
- The volume of boiler tank 18 Lt
- Wash temperature at 50-55 °C
- Rinse temperature at 50-55 °C
- Consumes 0.6 liters of water each rinse
- Internal cabinet height 480 mm
- Wash motor power 1, 1 x2 kW
- Tank resistance power is 6 kW
- Boiler resistance power is 18 kW
- Net weight 255 Kg



M036-T1

Teknik Özellikler | Technical Features

Ürün Kodu Product Code	Enerji Tipi Energy Type	Güç (kW/) Power (kW/)	Kapasite (Tabak/Saat) Capacity (Plate/Hour)	Ebat (cm) Dimensions (cm)	Ağırlık (Kg.) Weight (Kg.)	Fiyat Price
M036-T1	⚡	1,5	1500-2000	77x177,5x254	255	6930 €



Servis Hatları

Service Unit Line

Servis Hatları
Service Unit Line

Self Servis Üniteleri

Service Unit Lines

Soğuk Servis Ünitesi & Soğutmalı Teşhir Ünitesi

Cold Service Unit & Refrigerated Display Unit

Temel Özellikler

- Elektrikli -2 / +5 °c
- Gövde ve paneller paslanmaz çeliktir
- Termostatik kontrollüdür
- Gövde ve kapılar izolasyonludur
- Soğutma sistemi: Hermetik hava soğutmalı kondenser
- Bakır evaporatörlü statik soğutma yiyeceklerin soğuk ortamda teşhirini sağlar
- Soğuk servis ünitelerinde soğutucu 404A
- Soğutmalı teşhir ünitelerinde soğutucu R1 34A

Basic Features

- Electric -2 / +5 °c
- Body and panels are stainless steel
- It is thermostatic controlled
- Body and doors are insulated
- Cooling system: Hermetic air cooled condenser
- Static cooling with copper evaporator provides display of food in cold environment
- Refrigerant 404A in cold service units
- Refrigerant R1 34A in refrigerated display units

Soğutmalı Teşhir Ünitesi

Refrigerated Display Unit



E-SS37-3

E-SS37-6

Teknik Özellikler | Technical Features

Ürün Kodu Product Code	Enerji Tipi Energy Type	Gerilim (Volt/Hz) Voltage (Volt/Hz)	Güç (kW/) Power (kW/)	Kapasite Capacity	Gaz Tipi Gas Type	Soğutma Aralığı Cooling Range	Ebat (cm) Dimensions (cm)	Ağırlık (Kg.) Weight (Kg.)	Fiyat Price
E-SS37-6	⚡	230 / 50-60	1/3 Hp	1/1 GN-3'lü	-	0°C, +4°C	120x70x85 / 135	135	1540 €
E-SS37-8	⚡	230 / 50-60	1/3 Hp	1/1 GN-4'lü	-	0°C, +4°C	150x70x85 / 135	165	1820 €
E-SS37-10	⚡	230 / 50-60	1/2 Hp	1/1 GN-5'li	-	0°C, +4°C	200x70x85 / 135	191	2100 €
E-SS37-3	⚡	230 / 50-60	1/3 Hp	-	134a	0°C, +4°C	100x70x160	210	2240 €
E-SS37-4	⚡	230 / 50-60	1/3 Hp	-	134a	0°C, +4°C	150x70x160	234	2520 €

Gazlı Sulu Tip Bain Marie

Gas Type Bain Marie (Watery Type)

Temel Özellikler

- Doğal gaz, lpg veya elektrikle çalışma
- Gövde paslanmaz çelik
- Üst taban pleyt tablalı
- Üst taban gövde izolasyonlu
- Servis rafı, tepsi kaydırma standlı
- İsteğe bağlı ön ahşap kaplama

Basic Features

- Works with Natural gas, lpg or electric
- Body and water containers are stainless steel
- The pool is with evacuating faucet
- Service shelf, tray sliding stand
- Front wooden covering (optional)



BE/M037-4S

Teknik Özellikler | Technical Features

Ürün Kodu Product Code	Enerji Tipi Energy Type	Gaz (Mbar) Gas (Mbar)	Güç (kW/kcal) Power (kW/kcal)	Kapasite Capacity	Ebat (cm) Dimensions (cm)	Ağırlık (Kg.) Weight (Kg.)	Fiyat Price
BE/M037-3S	🔥	21/25-30/50	4,4/3784	1 / 1 GN - 3'lü	120x70x85 / 135	86	1120 €
BE/M037-4S	🔥	21/25-30/50	4,4/3784	1 / 1 GN - 4'lü	150x70x85 / 135	100	1230 €
BE1/M037-5S	🔥	21/25-30/50	8,8/7568	1 / 1 GN - 5'li	180x70x85 / 135	115	1400 €
BE1/M037-6S	🔥	21/25-30/50	8,8/7568	1 / 1 GN - 6'li	220x70x85 / 135	140	1680 €

Self Servis Üniteleri

Service Unit Lines

Elektrikli Sulu Tip Bain Marie

Electrical Bain Marie (Watery Type)

Temel Özellikler

- Monofaze ve trifaze elektrikli
- Termostat kontrollü
- Gövde paslanmaz çelik
- Havuz su tahliye musluklu
- Servis raflı, Tepsiler kaydırma standlı
- İsteğe bağlı ön ahşap kaplama

Basic Features

- Works with monophase or threephase
- Thermostat control
- Stainless steel body
- Pool with evacuating faucet
- Service shelf, tray sliding stand
- Front wooden cover (optional)



M037-4SE

Teknik Özellikler | Technical Features

Ürün Kodu Product Code	Enerji Tipi Energy Type	Gerilim (Volt/Hz) Voltage (Volt/Hz)	Güç (kW/) Power (kW/)	Kapasite Capacity	Ebat (cm) Dimensions (cm)	Ağırlık (Kg.) Weight (Kg.)	Fiyat Price
M037-3SE	⚡	230 / 50-60	2	1 / 1 GN - 3'lü	120x70x85 / 135	86	1090 €
M037-4SE	⚡	230 / 50-60	2,5	1 / 1 GN - 4'lü	150x70x85 / 135	100	1160 €
M037-5SE	⚡	230 / 50-60	4	1 / 1 GN - 5'li	180x70x85 / 135	115	1370 €
M037-6SE	⚡	230 / 50-60	4	1 / 1 GN - 6'li	220x70x85 / 135	140	1650 €

Bain Marieler (Kuru-Sulu Tip)

Bain Maries (Dry-Watery Type)

Temel Özellikler

- LPG, D. Gaz ile çalışır
- Gövde su haznesi paslanmaz çeliktir
- Havuz su tahliye muslukludur
- Servis rafı, tepsi kaydırma standlı
- İsteğe bağlı ön ahşap kaplama

Basic Features

- Works with Natural gas, lpg
- Body and water containers are stainless steel
- The pool is with evacuating faucet
- Service shelf, tray sliding stand
- Front wooden cover (optional) (optional)

**BE/M037-4K****Teknik Özellikler | Technical Features**

Ürün Kodu Product Code	Enerji Tipi Energy Type	Gaz (Mbar) Gas (Mbar)	Güç (kW/kcal) Power (kW/kcal)	Kapasite (Tepsi) Capacity (Tray)	Ebat (cm) Dimensions (cm)	Ağırlık (Kg.) Weight (Kg.)	Fiyat Price
BE/M037-3K	🔥	21/25-30/50	4,4/3784	2+4	120x70x85 / 135	86	1610 €
BE/M037-4K	🔥	21/25-30/50	4,4/3784	2+6	150x70x85 / 135	100	1720 €
BE1/M037-5K	🔥	21/25-30/50	8,8/7568	2+8	180x70x85 / 135	115	1890 €
BE1/M037-6K	🔥	21/25-30/50	8,8/7568	2+10	220x70x85 / 135	140	2170 €

Self Servis Üniteleri

Service Unit Lines

Elektrikli Setüstü Bain Marieler

Electrical Set Type Bain Maries

Temel Özellikler

- Monofaze, trifaze elektrikli
- Termostat kontrollü
- Gövde su haznesi paslanmaz çelik
- GN Standart kaplara uyumlu
- Paslanmaz rezistans ısıtıcı
- Hijyenik, ergonomik konstrüksiyon ve emniyetli

Basic Features

- Works with monophase or threephase
- Thermostat control
- Body and water tank is stainless steel
- Compatible with Gn standard containers
- Stainless resistance heater
- Hygienic, ergonomic construction and safe



Teknik Özellikler | Technical Features

Ürün Kodu Product Code	Enerji Tipi Energy Type	Gerilim (Volt/Hz) Voltage (Volt/Hz)	Güç (kW/) Power (kW/)	Kapasite Capacity	Ebat (cm) Dimensions (cm)	Ağırlık (Kg.) Weight (Kg.)	Fiyat Price
MXS037-3S	⚡	230 / 50-60	2	1 / 1 GN - 3'lü	120x70x30	52	620 €
MXS037-4S	⚡	230 / 50-60	2,5	1 / 1 GN - 4'lü	150x70x30	58	690 €
MXS037-5S	⚡	230 / 50-60	4	1 / 1 GN - 5'li	180x70x30	67	770 €

Kuver Ünitesi

Cutlery Unit

Temel Özellikler

- Komple paslanmaz çelikten imal edilmiştir
- Çatal, kaşık, bıçak ve tepsi hazneli
- Taban dolaplı
- Ön ahşap kaplama seçeneği
- Hijyenik, emniyetli ve uzun ömürlü
- Sağlam, ergonomik

Basic Features

- Stainless steel
- Fork, spoon, knife container
- It has sliding stand in the front face
- With bottom cupboard
- Wooden front cover option
- Size option according to Project



PVK60

Teknik Özellikler | Technical Features

Ürün Kodu Product Code	Kapasite (GN1/4x15) Capacity (GN1 / 4x15)	Ebat (cm) Dimensions (cm)	Ağırlık (Kg.) Weight (Kg.)	Fiyat Price
PVK60	3 Adet/Pieces	60x70x85 / 135	33	460 €
PVK80	4 Adet/Pieces	80x70x85 / 135	47	530 €
PVK100	6 Adet/Pieces	100x70x85 / 135	76	600 €

Self Servis Üniteleri

Service Unit Lines

Nötr Tezgah

Neutral Mid Table

Temel Özellikler

- Komple paslanmaz çelikten imal edilmiştir
- Tablalı etrafı kapalı
- Ön ahşap kaplama seçeneği
- Hijyenik, emniyetli ve uzun ömürlü
- Sağlam, ergonomik

Temel Özellikler

- It is completely made of stainless steel
- Covered table is covered
- Front wood veneer option
- Hygienic, safe and long-lasting
- Robust, ergonomic



MX037-1 MBL

Teknik Özellikler | Technical Features

Ürün Kodu Product Code	Ebat (cm) Dimensions (cm)	Ağırlık (Kg.) Weight (Kg.)	Fiyat Price
MX037-1 MBL	80x70x85 / 135	80	560 €
MX037-1	80x70x85 / 135	75	520 €
MX037-2	120x70x85 / 135	90	630 €
MX037-3	150x70x85 / 135	100	810 €
MX037-4	180x70x85 / 135	115	910 €

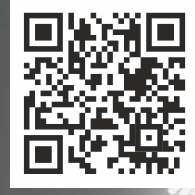

Mutfak Ekipmanları

Kitchen Equipments

Mutfak Ekipmanları

Kitchen Equipments

Tablasız Çalışma Tezgahı | Work Bench Without Shelf

Ürün Kodu Product Code	Ebat (mm) Dimensions (mm)	Ağırlık (Kg.) Weight (Kg.)	Fiyat Price
PİMAK.06060.00	600x600x850	16	190 €
PİMAK.09060.00	900x600x850	19	230 €
PİMAK.10060.00	1000x600x850	20	240 €
PİMAK.12060.00	1200x600x850	22	270 €
PİMAK.14060.00	1400x600x850	24	290 €
PİMAK.16060.00	1600x600x850	27	320 €
PİMAK.19060.00	1900x600x850	30	370 €
PİMAK.06070.00	600x700x850	17	210 €
PİMAK.09070.00	900x700x850	20	240 €
PİMAK.10070.00	1000x700x850	22	260 €
PİMAK.12070.00	1200x700x850	24	280 €
PİMAK.14070.00	1400x700x850	26	310 €
PİMAK.16070.00	1600x700x850	29	330 €
PİMAK.19070.00	1900x700x850	32	380 €



Taban Rafli Çalışma Tezgahı | Work Bench With Bottom Shelf

Ürün Kodu Product Code	Ebat (mm) Dimensions (mm)	Ağırlık (Kg.) Weight (Kg.)	Fiyat Price
PİMAK.06060.08	600x600x850	19	230 €
PİMAK.09060.08	900x600x850	24	310 €
PİMAK.10060.08	1000x600x850	25	320 €
PİMAK.12060.08	1200x600x850	29	370 €
PİMAK.14060.08	1400x600x850	32	400 €
PİMAK.16060.08	1600x600x850	35	430 €
PİMAK.19060.08	1900x600x850	40	480 €
PİMAK.06070.08	600x700x850	20	250 €
PİMAK.09070.08	900x700x850	26	340 €
PİMAK.10070.08	1000x700x850	27	360 €
PİMAK.12070.08	1200x700x850	31	390 €
PİMAK.14070.08	1400x700x850	35	420 €
PİMAK.16070.08	1600x700x850	38	470 €
PİMAK.19070.08	1900x700x850	44	510 €



Taban ve Ara Rafli Çalışma Tezgahı | Work Bench With Mid and Bottom Shelf

Ürün Kodu Product Code	Ebat (mm) Dimensions (mm)	Ağırlık (Kg.) Weight (Kg.)	Fiyat Price
PİMAK.06060.04	600x600x850	24	270 €
PİMAK.09060.04	900x600x850	31	380 €
PİMAK.10060.04	1000x600x850	33	390 €
PİMAK.12060.04	1200x600x850	38	440 €
PİMAK.14060.04	1400x600x850	43	480 €
PİMAK.16060.04	1600x600x850	48	520 €
PİMAK.19060.04	1900x600x850	55	580 €
PİMAK.06070.04	600x700x850	26	300 €
PİMAK.09070.04	900x700x850	34	390 €
PİMAK.10070.04	1000x700x850	36	420 €
PİMAK.12070.04	1200x700x850	42	460 €
PİMAK.14070.04	1400x700x850	47	510 €
PİMAK.16070.04	1600x700x850	52	550 €
PİMAK.19070.04	1900x700x850	60	630 €



Dolaplı Çalışma Tezgahları | Work Bench Without Shelf



Ürün Kodu Product Code	Ebat (mm) Dimensions (mm)	Ağırlık (Kg.) Weight (Kg.)	Fiyat Price
PİMAK.06060.13	700x600x850	29	370 €
PİMAK.09060.13	900x600x850	35	430 €
PİMAK.10060.13	1000x600x850	38	510 €
PİMAK.12060.13	1200x600x850	44	490 €
PİMAK.14060.13	1400x600x850	50	550 €
PİMAK.16060.13	1600x600x850	55	700 €
PİMAK.19060.13	1900x600x850	64	810 €
PİMAK.22060.13	2200x600x850	73	910 €
PİMAK.24060.13	2400x600x850	79	1000 €
PİMAK.06070.13	600x700x850	28	370 €
PİMAK.09070.13	900x700x850	38	500 €
PİMAK.10070.13	1000x700x850	41	600 €
PİMAK.12070.13	1200x700x850	47	690 €
PİMAK.14070.13	1400x700x850	53	760 €
PİMAK.16070.13	1600x700x850	59	820 €
PİMAK.19070.13	1900x700x850	69	940 €
PİMAK.22070.13	2200x700x850	79	1070 €

Dolaplı Çalışma Tezgahı – Ara Rafli Blok Çekmeceli | Work Bench With Cupboard, Block Drawers and Mid Shelf



Ürün Kodu Product Code	Ebat (mm) Dimensions (mm)	Ağırlık (Kg.) Weight (Kg.)	Fiyat Price
PİMAK.12060.56	1200x600x850	68	1240 €
PİMAK.14060.56	1400x600x850	76	1390 €
PİMAK.16060.56	1600x600x850	83	1510 €
PİMAK.19060.56	1900x600x850	94	1710 €
PİMAK.24060.56	2400x600x850	112	1930 €
PİMAK.12070.56	1200x700x850	73	1330 €
PİMAK.14070.56	1400x700x850	80	1460 €
PİMAK.16070.56	1600x700x850	88	1600 €
PİMAK.19070.56	1900x700x850	100	1820 €
PİMAK.24070.56	2400x700x850	120	2180 €

Dolaplı Çalışma Tezgahı – Ara Rafli | WoCabinet Work Bench Intermediate Shelf



Ürün Kodu Product Code	Ebat (mm) Dimensions (mm)	Ağırlık (Kg.) Weight (Kg.)	Fiyat Price
PİMAK.12060.73	1200x600x850	53	650 €
PİMAK.14060.73	1400x600x850	61	720 €
PİMAK.16060.73	1600x600x850	68	800 €
PİMAK.19060.73	1900x600x850	79	900 €
PİMAK.24060.73	2400x600x850	97	1110 €
PİMAK.12070.73	1200x700x850	58	760 €
PİMAK.14070.73	1400x700x850	65	830 €
PİMAK.16070.73	1600x700x850	73	910 €
PİMAK.19070.73	1900x700x850	85	1030 €
PİMAK.24070.73	2400x700x850	105	1270 €

Mutfak Ekipmanları

Kitchen Equipments

Tabak Isıtma Dolabı | Plate (Dish) Warming Appliance

Ürün Kodu Product Code	Ebat (mm) Dimensions (mm)	Ağırlık (Kg.) Weight (Kg.)	Fiyat Price
PİMAK.10608.23	1000x600x850	56	730 €
PİMAK.12608.23	1200x600x850	63	860 €
PİMAK.14608.23	1400x600x850	71	950 €
PİMAK.16608.23	1600x600x850	78	1030 €
PİMAK.19608.23	1900x600x850	89	1170 €
PİMAK.10708.23	1000x700x850	60	820 €
PİMAK.12708.23	1200x700x850	68	910 €
PİMAK.14708.23	1400x700x850	75	1010 €
PİMAK.16708.23	1600x700x850	83	1070 €
PİMAK.19708.23	1900x700x850	95	1380 €



Set Altı Dolaplı Çalışma Tezgahı | Under Counter Work Bench

Ürün Kodu Product Code	Ebat (mm) Dimensions (mm)	Ağırlık (Kg.) Weight (Kg.)	Fiyat Price
PİMAK.12060.52	1200x600x550	34	420 €
PİMAK.14060.52	1400x600x550	39	470 €
PİMAK.16060.52	1600x600x550	44	430 €
PİMAK.19060.52	1900x600x550	51	620 €
PİMAK.12070.52	1200x700x550	37	450 €
PİMAK.14070.52	1400x700x550	42	510 €
PİMAK.16070.52	1600x700x550	47	570 €
PİMAK.19070.52	1900x700x550	55	670 €



Hareketli Tezgah – Taban ve Ara Rafı | Work Bench With Bottom Shelf, With Trolley

Ürün Kodu Product Code	Ebat (mm) Dimensions (mm)	Ağırlık (Kg.) Weight (Kg.)	Fiyat Price
PİMAK.10060.15	1000x600x850	34	450 €
PİMAK.12060.15	1200x600x850	39	480 €
PİMAK.14060.15	1400x600x850	44	530 €
PİMAK.16060.15	1600x600x850	49	570 €
PİMAK.19060.15	1900x600x850	56	630 €
PİMAK.10070.15	1000x700x850	37	480 €
PİMAK.12070.15	1200x700x850	43	540 €
PİMAK.14070.15	1400x700x850	48	570 €
PİMAK.16070.15	1600x700x850	53	610 €
PİMAK.19070.15	1900x700x850	62	690 €



Hareketli Tezgah – Taban Rafı | Work Bench With Mid, Bottom Shelf and Trolley

Ürün Kodu Product Code	Ebat (mm) Dimensions (mm)	Ağırlık (Kg.) Weight (Kg.)	Fiyat Price
PİMAK.10060.70	1000x600x850	26	360 €
PİMAK.12060.70	1200x600x 850	29	390 €
PİMAK.14060.70	1400x600x 850	33	430 €
PİMAK.16060.70	1600x600x 850	36	460 €
PİMAK.19060.70	1900x600x 850	42	500 €
PİMAK.10070.70	1000x700x850	28	390 €
PİMAK.12070.70	1200x700x 850	32	420 €
PİMAK.14070.70	1400x700x 850	36	460 €
PİMAK.16070.70	1600x700x 850	40	490 €
PİMAK.19070.70	1900x700x 850	45	540 €



Mermer Tablalı Tezgah | Bench With Marble Table



Ürün Kodu Product Code	Ebat (mm) Dimensions (mm)	Ağırlık (Kg.) Weight (Kg.)	Fiyat Price
PİMAK.12060.50	1200x600x850	78	360 €
PİMAK.14060.50	1400x600x850	90	390 €
PİMAK.16060.50	1600x600x850	103	440 €
PİMAK.19060.50	1900x600x850	125	470 €
PİMAK.12070.50	1200x700x850	91	390 €
PİMAK.14070.50	1400x700x850	105	410 €
PİMAK.16070.50	1600x700x850	120	480 €
PİMAK.19070.50	1900x700x850	145	530 €

Mermer Tablalı Tezgah - Taban Rafı | Bench With Marble Table – Base Shelf



Ürün Kodu Product Code	Ebat (mm) Dimensions (mm)	Ağırlık (Kg.) Weight (Kg.)	Fiyat Price
PİMAK.12060.46	1200x600x850	72	410 €
PİMAK.14060.46	1400x600x850	84	460 €
PİMAK.16060.46	1600x600x850	96	510 €
PİMAK.19060.46	1900x600x850	116	540 €
PİMAK.12070.46	1200x700x850	85	450 €
PİMAK.14070.46	1400x700x850	98	460 €
PİMAK.16070.46	1600x700x850	112	540 €
PİMAK.19070.46	1900x700x850	135	600 €

Bulaşık Makinesi Giriş-Çıkış Tezgahı | Dish Washer Bench



Ürün Kodu Product Code	Ebat (mm) Dimensions (mm)	Bölüm Section	Fiyat Price
PİMAK.12070.57	700x750x850	Giriş/Loading Pre-Washing	390 €
PİMAK.14070.57	1000x750x850	Giriş/Loading Pre-Washing	420 €
PİMAK.16070.57	1200x750x850	Giriş/Loading Pre-Washing	440 €
PİMAK.12080.57	700x750x850	Çıkış / Discharging	300 €
PİMAK.14080.57	1000x750x850	Çıkış / Discharging	320 €
PİMAK.16080.57	1200x750x850	Çıkış / Discharging	340 €

Polietilen Tablalı Tezgah | Polythene Bench



Ürün Kodu Product Code	Ebat (mm) Dimensions (mm)	Ağırlık (Kg.) Weight (Kg.)	Kalınlık (mm.) Thickness (mm.)	Fiyat Price
PİMAK.12060.31	1200x600x850	45	40mm	370 €
PİMAK.14060.31	1400x600x850	49	40mm	410 €
PİMAK.16060.31	1600x600x850	53	40mm	440 €
PİMAK.19060.31	1900x600x850	58	40mm	500 €
PİMAK.12070.31	1200x700x850	49	40mm	400 €
PİMAK.14070.31	1400x700x850	60	40mm	450 €
PİMAK.16070.31	1600x700x850	64	40mm	490 €
PİMAK.19070.31	1900x700x850	70	40mm	550 €

Mutfak Ekipmanları

Kitchen Equipments

Polietilen Tablalı Tezgah – Taban Rafı | Polythene – Bottom Shelf

Ürün Kodu Product Code	Ebat (mm) Dimensions (mm)	Ağırlık (Kg.) Weight (Kg.)	Kalınlık (mm.) Thickness (mm.)	Fiyat Price
PİMAK.12060.51	1200x600x850	54	40mm	410 €
PİMAK.14060.51	1400x600x850	60	40mm	480 €
PİMAK.16060.51	1600x600x850	66	40mm	530 €
PİMAK.19060.51	1900x600x850	73	40mm	600 €
PİMAK.12070.51	1200x700x850	60	40mm	460 €
PİMAK.14070.51	1400x700x850	72	40mm	530 €
PİMAK.16070.51	1600x700x850	78	40mm	590 €
PİMAK.19070.51	1900x700x850	85	40mm	670 €



Et Kütüğü Polietilen Tablalı | Chopping Block With Polyethiene Top

Ürün Kodu Product Code	Ebat (mm) Dimensions (mm)	Ağırlık (Kg.) Weight (Kg.)	Kalınlık (mm.) Thickness (mm.)	Fiyat Price
PİMAK.05050.91	500x600x850	32	40mm	260 €
PİMAK.06060.91	600x600x850	38	40mm	320 €
PİMAK.06070.91	600x700x850	44	40mm	380 €
PİMAK.07070.91	700x700x850	52	40mm	440 €



Süzme Havuzlu Tezgah | Drained Pool Bench

Ürün Kodu Product Code	Ebat (mm) Dimensions (mm)	Fiyat Price
PİMAK.12060.31	1200x600x850	440 €
PİMAK.14060.31	1400x600x850	480 €
PİMAK.16060.31	1600x600x850	580 €
PİMAK.19060.31	1900x600x850	650 €
PİMAK.12070.31	1200x700x850	480 €
PİMAK.14070.31	1400x700x850	510 €
PİMAK.16070.31	1600x700x850	630 €
PİMAK.19070.31	1900x700x850	720 €

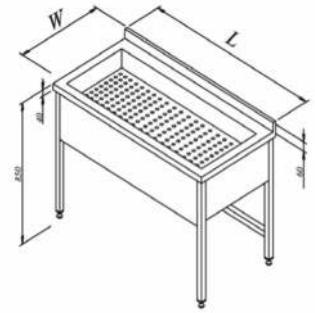

Balık Hazırlama Tezgahı | Fish Preparation Bench

Ürün Kodu Product Code	Ebat (mm) Dimensions (mm)	Fiyat Price
PİMAK.14070.25	1400x700x850	670 €
PİMAK.16070.25	1600x700x850	720 €
PİMAK.18070.25	1800x700x850	770 €
PİMAK.19070.25	1900x700x850	790 €
PİMAK.21070.25	2100x700x850	840 €
PİMAK.24070.25	2400x700x850	920 €



Tek Evyeli Taban Rafsız Tezgah | Single Sing Type Bench Without Base Shelf



KOD CODE	Ürün Kodu Product Code	Ebat (mm) Dimensions (mm)	Ağırlık (Kg.) Weight (Kg.)	Fiyat Price
M028	PİMAK.06060.11	600x600x850	22	290 €
M028	PİMAK.07060.11	700x600x850	23	320 €
M028	PİMAK.08060.11	800x600x850	25	340 €
M028	PİMAK.10060.11	1000x600x850	27	370 €
M028	PİMAK.12060.11	1200x600x850	29	410 €
M028	PİMAK.14060.11	1400x600x850	32	450 €
M028	PİMAK.16060.11	1600x600x850	34	480 €
M028	PİMAK.18060.11	1800x600x850	37	510 €
M028	PİMAK.20060.11	2000x600x850	39	530 €
M028	PİMAK.06070.11	600x700x850	24	330 €
M028	PİMAK.07070.11	700x700x850	25	350 €
M028	PİMAK.08070.11	800x700x850	26	370 €
M028	PİMAK.10070.11	1000x700x850	29	410 €
M028	PİMAK.12070.11	1200x700x850	31	440 €
M028	PİMAK.14070.11	1400x700x850	34	480 €
M028	PİMAK.16070.11	1600x700x850	37	510 €
M028	PİMAK.18070.11	1800x700x850	39	550 €
M028	PİMAK.20070.11	2000x700x850	42	580 €

Çift Evyeli Taban Rafsız Tezgah | Double Sing Type Bench Without Base Shelf



KOD CODE	Ürün Kodu Product Code	Ebat (mm) Dimensions (mm)	Ağırlık (Kg.) Weight (Kg.)	Fiyat Price
M029	PİMAK.12060.17	1200x600x850	34	490 €
M029	PİMAK.14060.17	1400x600x850	37	530 €
M029	PİMAK.16060.17	1600x600x850	39	560 €
M029	PİMAK.18060.17	1800x600x850	42	600 €
M029	PİMAK.20060.17	2000x600x850	44	620 €
M029	PİMAK.22060.17	2200x600x850	47	650 €
M029	PİMAK.24060.17	2400x600x850	49	680 €
M029	PİMAK.12070.17	1200x700x850	36	540 €
M029	PİMAK.14070.17	1400x700x850	39	590 €
M029	PİMAK.16070.17	1600x700x850	42	610 €
M029	PİMAK.18070.17	1800x700x850	44	650 €
M029	PİMAK.20070.17	2000x700x850	47	660 €
M029	PİMAK.22070.17	2200x700x850	49	690 €
M029	PİMAK.24070.17	2400x700x850	52	740 €

Üç Evyeli Taban Rafsız Tezgah | Triple Sing Type Bench Without Base Shelf



KOD CODE	Ürün Kodu Product Code	Ebat (mm) Dimensions (mm)	Evyeye Ebat (mm) Sink Dim. (mm)	Ağırlık(Kg.) Weight(Kg.)	Fiyat Price
ET 104	PİMAK.18060.98	1800x600x850	400x400x250	47	700 €
ET 104	PİMAK.18060.99	1800x600x850	400x500x250	47	720 €
ET 104	PİMAK.19060.98	1900x600x850	400x400x250	48	720 €
ET 104	PİMAK.19060.99	1900x600x850	400x500x300	48	730 €
ET 104	PİMAK.18070.98	1800x700x850	500x500x300	49	740 €
ET 104	PİMAK.19070.98	1900x700x850	500x500x300	49	760 €
ET 104	PİMAK.20070.98	2000x700x850	500x500x300	52	790 €

Mutfak Ekipmanları

Kitchen Equipments

Bulaşık Sıyırma Tezgahı | Bench With Dish Sacrapping Hole

Ürün Kodu Product Code	Ebat (mm) Dimensions (mm)	Ağırlık (Kg.) Weight (Kg.)	Fiyat Price
PİMAK.2809060	900x600x850	20	260 €
PİMAK.2810060	1000x600x850	22	280 €
PİMAK.2812060	1200x600x850	24	310 €
PİMAK.2814060	1400x600x850	26	330 €
PİMAK.2816060	1600x600x850	29	360 €
PİMAK.2809070	900x700x850	22	280 €
PİMAK.2810070	1000x700x850	23	300 €
PİMAK.2812070	1200x700x850	26	330 €
PİMAK.2814070	1400x700x850	28	360 €
PİMAK.2816070	1600x700x850	31	390 €



Kazan ve Tencere Yıkama Tezgahı | Pot Washing Unit

Ürün Kodu Product Code	Ebat (mm) Dimensions (mm)	Ağırlık (Kg.) Weight (Kg.)	Fiyat Price
PİMAK.2809070	900x800x600/900	26	460 €
PİMAK.2810070	1000x800x600/900	28	480 €
PİMAK.2812070	1200x800x 600/900	34	510 €
PİMAK.2814070	1400x800x 600/900	38	550 €
PİMAK.2816070	1600x800x 600/900	43	620 €
PİMAK.2816070	1900x800x 600/900	60	690 €



Orta Tip Filtresiz Davlumbaz | Middle Type Hood With Filter

Ürün Kodu Product Code	Ebat (mm) Dimensions (mm)	Ağırlık (Kg.) Weight (Kg.)	Fiyat Price
PİMAK.25155.00	2000x1500x500	69	810 €
PİMAK.25155.00	2500x1500x500	85	910 €
PİMAK.30155.00	3000x1500x500	102	1040 €
PİMAK.35155.00	3500x1500x500	119	1220 €
PİMAK.40155.00	4000x1500x500	135	1330 €
PİMAK.45155.00	4500x1500x500	152	1490 €
PİMAK.50155.00	5000x1500x500	168	1630 €
PİMAK.55155.00	5500x1500x500	185	1810 €
PİMAK.60155.00	6000x1500x500	202	1930 €
PİMAK.25155.00	2000x2000x500	77	880 €
PİMAK.25205.00	2500x2000x500	95	970 €
PİMAK.30205.00	3000x2000x500	114	1090 €
PİMAK.35205.00	3500x2000x500	133	1260 €
PİMAK.40205.00	4000x2000x500	151	1370 €
PİMAK.45205.00	4500x2000x500	170	1540 €
PİMAK.50205.00	5000x2000x500	188	1680 €
PİMAK.55205.00	5500x2000x500	207	1860 €
PİMAK.60205.00	6000x2000x500	226	1960 €



Filtreli Orta Tip Davlumbazlar | Middle Type Hood With Filter

Ürün Kodu Product Code	Ebat (mm) Dimensions (mm)	Ağırlık (Kg.) Weight (Kg.)	Fiyat Price
PİMAK.15155.10	1500x1500x500	68	1140 €
PİMAK.20155.10	2000x1500x500	84	1260 €
PİMAK.25155.10	2500x1500x500	102	1400 €
PİMAK.30155.10	3000x1500x500	120	1650 €
PİMAK.35155.10	3500x1500x500	138	1890 €
PİMAK.40155.10	4000x1500x500	138	2100 €
PİMAK.45155.10	4500x1500x500	168	2350 €
PİMAK.50155.10	5000x1500x500	191	2560 €
PİMAK.55155.10	5500x1500x500	204	2800 €
PİMAK.60155.10	6000x1500x500	226	3010 €
PİMAK.25205.10	2500x2000x500	116	1470 €
PİMAK.30205.10	3000x2000x500	136	1720 €
PİMAK.35205.10	3500x2000x500	155	1960 €
PİMAK.40205.10	4000x2000x500	174	2170 €
PİMAK.45205.10	4500x2000x500	188	2420 €
PİMAK.50205.10	5000x2000x500	213	2630 €
PİMAK.55205.10	5500x2000x500	238	2840 €
PİMAK.60205.10	6000x2000x500	251	3080 €
PİMAK.25255.10	2500x2500x500	132	1760 €
PİMAK.30255.10	3000x2500x500	153	2120 €
PİMAK.35255.10	3500x2500x500	174	2470 €
PİMAK.40255.10	4000x2500x500	195	3440 €
PİMAK.45255.10	4500x2500x500	211	3170 €
PİMAK.50255.10	5000x2500x500	239	3510 €
PİMAK.55255.10	5500x2500x500	255	3860 €
PİMAK.60255.10	6000x2500x500	280	4210 €



Filtresiz Duvar Tipi Davlumbaz | Wall Type Hood Without Filter

Ürün Kodu Product Code	Ebat (mm) Dimensions (mm)	Ağırlık (Kg.) Weight (Kg.)	Fiyat Price
PİMAK.10095.01	1000x1000x500	31	430 €
PİMAK.15095.01	1500x1000x500	45	560 €
PİMAK.20095.01	2000x1000x500	59	630 €
PİMAK.25095.01	2500x1000x500	73	730 €
PİMAK.30095.01	3000x1000x500	88	830 €
PİMAK.35095.01	3500x1000x500	102	930 €
PİMAK.40095.01	4000x1000x500	116	1020 €
PİMAK.12115.00	1200x1200x 500	38	550 €
PİMAK.15115.00	1500x1200x500	47	600 €
PİMAK.20115.00	2000x1200x500	62	680 €
PİMAK.25115.00	2500x1200x500	77	790 €
PİMAK.30115.00	3000x1200x500	92	910 €
PİMAK.35115.00	3500x1200x500	107	1000 €
PİMAK.40115.00	4000x1200x500	122	1110 €
PİMAK.15145.01	1500x1500x500	51	750 €
PİMAK.20145.01	2000x1500x500	67	830 €
PİMAK.25145.01	2500x1500x500	83	880 €
PİMAK.30145.01	3000x1500x500	100	950 €
PİMAK.35145.01	3500x1500x500	116	1070 €
PİMAK.40145.01	4000x1500x500	132	1180 €
PİMAK.45145.01	4500x1500x500	148	1320 €
PİMAK.50145.01	5000x1500x500	164	1440 €
PİMAK.55145.01	5500x1500x500	181	1510 €
PİMAK.60145.01	6000x1500x500	197	1600 €



Mutfak Ekipmanları

Kitchen Equipments

Filtreli Duvar Tipi Davlumbaz | Wall Type Hood Without Filter

Ürün Kodu Product Code	Ebat (mm) Dimensions (mm)	Ağırlık (Kg.) Weight (Kg.)	Fiyat Price
PİMAK.15095.10	1500x1000x500	44	770 €
PİMAK.20095.10	2000x1000x500	48	900 €
PİMAK.25095.10	2500x1000x500	58	1100 €
PİMAK.30095.10	3000x1000x500	72	1250 €
PİMAK.35095.10	3500x1000x500	85	1420 €
PİMAK.40095.10	4000x1000x500	97	1600 €
PİMAK.12115.10	1200x1200x 500	34	650 €
PİMAK.15115.10	1500x1200x500	44	820 €
PİMAK.20115.10	2000x1200x500	54	950 €
PİMAK.25115.10	2500x1200x500	64	1250 €
PİMAK.30115.10	3000x1200x500	75	1350 €
PİMAK.35115.10	3500x1200x500	84	1540 €
PİMAK.40115.10	4000x1200x500	95	1720 €
PİMAK.15145.10	1500x1500x500	49	870 €
PİMAK.20145.10	2000x1500x500	60	1180 €
PİMAK.25145.10	2500x1500x500	72	1420 €
PİMAK.30145.10	3000x1500x500	83	1500 €
PİMAK.35145.10	3500x1500x500	93	1680 €
PİMAK.40145.10	4000x1500x500	105	1910 €
PİMAK.45145.10	4500x1500x500	117	2090 €
PİMAK.50145.10	5000x1500x500	129	2350 €
PİMAK.55145.10	5500x1500x500	137	2590 €
PİMAK.60145.10	6000x1500x500	153	2800 €



Duvar Dolapları | Wall Cabinets

Ürün Kodu Product Code	Ebat (mm) Dimensions (mm)	Ağırlık (Kg.) Weight (Kg.)	Fiyat Price
MR38-904060.00	900x400x600	17	280 €
MR38-1204060.00	1200x400x600	20	410 €
MR38-1404060.00	1400x400x600	22	460 €
MR38-1604060.00	1600x400x600	24	510 €
MR38-1804060.00	1800x400x600	28	550 €
MR38-2004060.00	2000x400x600	36	600 €
MR38-1.904060.10	900x400x600	26	310 €
MR38-1.1204060.10	1200x400x600	29	460 €
MR38-1.1404060.10	1400x400x600	35	510 €
MR38-1.1604060.10	1600x400x600	38	570 €
MR38-1.1804060.10	1800x400x600	41	620 €
MR38-1.2004060.10	2000x400x600	46	680 €



Süzme Duvar Rafı | Draining Wall Shelf



Ürün Kodu Product Code	Ebat (mm) Dimensions (mm)	Ağırlık (Kg.) Weight (Kg.)	Fiyat Price
TB04-503030.00	500x300x300	3.8	80 €
TB04-703030.00	700x300x300	4.2	90 €
TB04-903030.00	900x300x300	4.7	110 €
TB04-1203030.00	1200x300x300	5.6	120 €
TB04-1403030.00	1400x300x300	6.2	125 €
TB04-1603030.00	1600x300x300	6.8	135 €
TB04-1803030.00	1800x300x300	7.5	150 €
TB04-2003030.00	2000x300x300	8.2	160 €

Duvar Rafı | Wall Shelf



Ürün Kodu Product Code	Ebat (mm) Dimensions (mm)	Ağırlık (Kg.) Weight (Kg.)	Fiyat Price
DR04-503030.00	500x300x300	3.8	60 €
DR04-703030.00	700x300x300	4.2	80 €
DR04-903030.00	900x300x300	4.7	90 €
DR04-1203030.00	1200x300x300	5.6	100 €
DR04-1403030.00	1400x300x300	6.2	110 €
DR04-1603030.00	1600x300x300	6.8	115 €
DR04-1803030.00	1800x300x300	7.5	120 €
DR04-2003030.00	2000x300x300	8.2	130 €

Mutfak Ekipmanları

Kitchen Equipments

İstif Rafları | Storage Shelves

Ebat (mm) Dimensions (mm)	Izgara Tabla(201) Grid Table (201)	Izgara Tabla(304) Grid Table (304)	Izgara Tabla(Kromaj) Grid Table (Chromage)	Düz Tabla(201) Smooth Table (201)	Düz Tabla(304) Smooth Table (304)
460x910x1830	240 €	300 €	160 €	310 €	360 €
460x1070x1830	260 €	320 €	170 €	330 €	390 €
460x1220x1830	270 €	340 €	180 €	360 €	420 €
460x1370x1830	310 €	380 €	200 €	450 €	520 €
460x1520x1830	330 €	410 €	210 €	480 €	560 €
460x1830x1830	370 €	460 €	240 €	550 €	440 €
530x910x1830	260 €	310 €	170 €	330 €	380 €
530x1070x1830	270 €	340 €	180 €	360 €	420 €
530x1220x1830	320 €	400 €	210 €	440 €	510 €
530x1370x1830	340 €	430 €	220 €	480 €	560 €
530x1520x1830	370 €	460 €	240 €	520 €	600 €
530x1830x1830	420 €	530 €	270 €	590 €	690 €
610x910x1830	280 €	350 €	190 €	360 €	410 €
610x1070x1830	310 €	380 €	200 €	440 €	510 €
610x1220x1830	340 €	430 €	220 €	470 €	550 €
610x1370x1830	370 €	460 €	240 €	520 €	600 €
610x1520x1830	400 €	500 €	260 €	560 €	650 €
610x1830x1830	460 €	570 €	290 €	640 €	740 €



Mutfak Bulaşık Arabaları | Kitchen Dish Trolleys



Ürün Kodu Product Code	Ürün Adı Product Name	Ebat (mm) Dimensions (mm)	Fiyat Price
-		370x530 Tekli	310 €
-		370x530 Çiftli	530 €
MT 152X	Tepsi Taşıma 1/1 <i>Tray Trolley 1/1</i>	440x630x1720	280 €
-		400x600 Tekli	320 €
-		400x600 Çiftli	560 €
MT 162X	Tepsi Taşıma2x1 <i>Tray Trolley for 70x50cm tray</i>	580x660x1720	320 €
MB 120X	Bulaşık Toplama/Havuzlu	850x550x900	280 €
MS 122X	Servis 2 Katlı <i>Service Trolley 2 Tiers</i>	910x530x900	250 €
MS 122X	Servis 3 Katlı <i>Service Trolley 3 Tiers</i>	550x860x900	280 €
MT 140X	Erzak Tek Kapaklı <i>Mobile Bin Single Lid</i>	560x550x500	220 €

Evyeli Arabalar | Trolleys with Sink



Ürün Kodu Product Code	Ürün Adı Product Name	Ebat (mm) Dimensions (mm)	Fiyat Price
MB 124X	Evyeli Araba <i>Sink</i>	500x760x900	320 €
MT 128X	Et-Balık Taşıma <i>Meat-Fish Trolley</i>	800x600x800	210 €
MB 172X	Kazan-Tencere Taşıma <i>Platform Trolley High</i>	900x600x500	260 €
MT 170X	Platform Düz Ayaklı <i>Trolley Solid</i>	800x600x200	320 €
MB 132X	Kaset Taşıma, Kollu <i>Basket Trolley With Handle</i>	500x500	130 €
MB 134X	Kaset Taşıma, Alçak <i>Basket Trolley With Rails-Low</i>	560x550x900	180 €
MB 136X	Kaset Taşıma, Yüksek <i>Basket Trolley With Rails-High</i>	560x550x1650	250 €

Mutfak Ekipmanları

Kitchen Equipments

Helvane Tencereler | Wide Shallow Pot

KOD CODE	Çap(Ø mm) Diameter (Ø mm)	Yükseklik (mm) Height (mm)	Kapasite (Kg.) Capacity (Kg.)	Fiyat Price
320.09.001	300	150	9.5	44 €
320.02.002	360	150	14	50 €
320.09.003	360	200	18	60 €
320.09.004	400	170	19	67 €
320.09.005	450	200	31	88 €
320.09.006	500	200	36	109 €
320.09.007	550	200	40	125 €
320.09.008	600	200	45	146 €
320.09.009	650	250	76	177 €
320.09.010	700	300	108	268 €
320.09.011	800	300	136	328 €
320.09.012	900	300	160	427 €
320.09.013	1000	300	160	600 €
320.09.014	1100	350	289	683 €



Kızartma Tavası | Frying Pan

KOD CODE	Çap(Ø mm) Diameter (Ø mm)	Yükseklik (mm) Height (mm)	Kapasite (Kg.) Capacity (Kg.)	Fiyat Price
321.01.203	360	60	6.1	52 €
321.01.002	360	90	9.2	58 €
321.01.205	400	80	10	63 €
321.01.004	400	110	14	68 €
321.01.005	450	120	19.1	88 €
321.01.011	500	120	26	101 €
321.01.006	550	140	33.2	125 €
321.01.010	600	140	51	156 €
321.01.007	650	140	46.4	190 €
321.01.008	700	150	57	206 €
321.01.009	800	160	80	333 €
350.03.546	900	200	120	372 €
321.01.003	1000	200	140	448 €
350.03.545	1100	200	180	644 €



Silindirik Tencere | Cylindrical Pot

KOD CODE	Çap(Ø mm) Diameter (Ø mm)	Yükseklik (mm) Height (mm)	Kapasite (Kg.) Capacity (Kg.)	Fiyat Price
320.10.001	160	160	3	29 €
320.10.002	180	180	4.5	30 €
320.10.030	200	200	6.3	34 €
320.10.003	240	200	8.4	47 €
320.10.004	240	240	9.8	50 €
320.10.005	280	280	17	70 €
320.10.006	320	320	26	88 €
320.10.007	350	35	35	112 €
320.10.008	400	40	52	137 €
320.10.009	450	45	70	196 €
320.10.023	500	50	100	256 €
320.10.195	600	55	170	545 €



Çöp Arabası | Garbage Trolley



Ürün Kodu Product Code	Model Model	Ağırlık (Kg.) Weight (Kg.)	Ebat (mm) Dimensions (mm)	Kapasite Capacity	Fiyat Price
331.01.021	Tekerlekli Wheeled	44	400x500	48 Lt.	240 €

Temel Özellikler

- 304 kalite paslanmaz
- Seyyar taşınması kolay
- Tekerlekli her yöne hareket edebilir
- Kapaklı ve hijyenik

Basic Features

- 304 grade stainless steel
- Portable, easy to carry
- Rollers can move in all directions
- Cover and hygienic

Yemek Taşıma Kapları | Carrying Container Unit



Ürün Kodu Product Code	Model Model	Çap (Ø mm) Diameter (Ø mm)	Yükseklik (mm) Heigh (mm)	Kapasite (Lt.) Capacity (Lt.)	Fiyat Price
331.01.021	Tabanlı	300	280	19	102 €
331.01.022	Tabansız	300	280	19	75 €
331.01.023	Tabanlı	300	320	22	110 €
331.01.024	Tabansız	300	320	22	89 €
331.01.025	Tabanlı	350	350	33	141 €
331.01.026	Tabansız	350	350	33	115 €
331.01.027	Tabanlı	400	400	40	162 €
331.01.028	Tabansız	400	400	50	135 €
331.01.029	Tabanlı	450	450	40	237 €
331.01.030	Tabansız	450	450	50	182 €
331.01.031	Tabanlı	500	500	92	285 €
331.01.032	Tabansız	500	500	92	225 €

Fırın Tepsisi Klips Kapaklı | Oven Tray with Lid Clip



Ürün Kodu Product Code	Model Model	Ebat (mm) Dimensions (mm)	Fiyat Price
5215000000000000	Kapak Dahil	350x450x80	74 €
5220000000000000	Kapak Dahil	450x600x50	91 €
5225000000000000	Kapak Dahil	450x600x80	95 €
5230000000000000	Kapak Dahil	500x700x80	102 €
5235000000000000	Kapak Dahil	500x700x100	119 €

Çift Cidarlı Yemek Termosu | Çift Cidarlı Yemek Termosu



Ürün Kodu Product Code	Çap (Ø mm) Diameter (Ø mm)	Yükseklik (mm) Heigh (mm)	Porsiyon Portion	Kapasite (Lt.) Capacity (Lt.)	Fiyat Price
321.01.203	320	170	40	5	161 €
321.01.002	320	230	60	10	175 €
321.01.205	320	310	80	15	186 €
321.01.004	320	470	120	20	203 €
321.01.005	320	470	120	28	228 €

Mutfak Ekipmanları

Kitchen Equipments

Sanayi Tipi Sefer Tası | Industry Type Expedition Bowl

KOD Code	Ebat(mm) Dimension(mm)	Açıklama Description	Kalınlık Thickness	Kapasite Capacity	Fiyat Price
321.01.203	160x80	Sanayi Tipi Sefertası 16/3	0,7	1,6 Lt.	39 €
321.01.002	160x80	Sanayi Tipi Sefertası 16/4	0,7	1,6 Lt.	49 €
321.01.205	160x80	Sanayi Tipi Sefertası 18/3	0,7	2 Lt.	44 €
321.01.004	180x80	Sanayi Tipi Sefertası 18/4	0,7	2 Lt.	57 €
321.01.005	180x80	Sanayi Tipi Sefertası 20/3	0,7	4,2 Lt.	52 €
321.01.011	180x80	Sanayi Tipi Sefertası 20/4	0,7	4,2 Lt.	68 €
321.01.006	200x140	Sanayi Tipi Sefertası 22/3	0,7	5 Lt.	63 €
321.01.010	200x140	Sanayi Tipi Sefertası 22/4	0,7	5 Lt.	78 €
321.01.007	220x140	Sanayi Tipi Sefertası 24/3	0,7	6,3 Lt.	70 €
321.01.008	220x140	Sanayi Tipi Sefertası 24/4	0,7	6,3 Lt.	94 €
321.01.009	240x140	Sanayi Tipi Sefertası 26/3	0,7	7,4 Lt.	83 €
350.03.546	240x140	Sanayi Tipi Sefertası 26/4	0,7	7,4 Lt.	107 €
321.01.003	260x140	Sanayi Tipi Sefertası 28/3	0,7	8,6 Lt.	101 €
350.03.545	260x140	Sanayi Tipi Sefertası 28/4	0,7	8,6 Lt.	117 €
350.03.547	280x140	Sanayi Tipi Sefertası 30/3	0,7	10 Lt.	96 €
350.03.548	280x140	Sanayi Tipi Sefertası 30/4	0,7	10 Lt.	130 €



Maxi Alüminyum Tava | Maxi Aluminium Frying Pan

Ürün Kodu Product Code	Çap(Ø mm) Diameter (Ø mm)	Yükseklik (mm) Heigh (mm)	Fiyat Price
321.01.002	200	-	17 €
321.01.205	220	-	19 €
321.01.004	240	-	21 €
321.01.005	260	-	25 €
321.01.011	280	-	27 €
321.01.006	300	-	30 €
321.01.010	320	-	32 €



Krep Alüminyum Tava | Crepe Aluminium Frying Pan

Ürün Kodu Product Code	Çap(Ø mm) Diameter (Ø mm)	Yükseklik (mm) Heigh (mm)	Fiyat Price
321.01.004	200	-	17 €
321.01.005	220	-	19 €
321.01.011	240	-	22 €
321.01.006	260	-	24 €
321.01.010	280	-	26 €
321.01.004	300	-	30 €
321.01.008	320	-	32 €



Wok Alüminyum Tava | Wok Aluminium Frying Pan

Ürün Kodu Product Code	Çap(Ø mm) Diameter (Ø mm)	Yükseklik (mm) Heigh (mm)	Fiyat Price
321.01.203	200	-	24 €
321.01.002	220	-	27 €
321.01.205	240	-	31 €
321.01.004	260	-	34 €
321.01.005	280	-	37 €



Yapışmaz Paslanmaz Çelik Tava | Non-Stick Stainless Steel Frying Pan



Ürün Kodu Product Code	Çap(Ø mm) Diameter (Ø mm)	Yükseklik (mm) Heigh (mm)	Fiyat Price
321.01.203	200	-	39 €
321.01.002	240	-	47 €
321.01.205	260	-	52 €
321.01.004	280	-	59 €
321.01.005	320	-	67 €

Standart Gastronom Küvet GN 2/1 650x530 | Standard Gastronom Container GN 2/1 650x530



Ürün Kodu Product Code	Porsiyon Portion	Yükseklik (mm) Heigh (mm)	Kapasite (Lt.) Capacity (Lt.)	Fiyat Price
321.01.203	20	20	5	24 €
321.01.002	40	40	10	26 €
321.01.205	72	65	18,5	31 €
321.01.004	112	100	28,5	38 €
321.01.005	170	150	42,5	62 €
321.01.005	230	200	57,5	70 €

Standart Gastronom Küvetler GN 1/1 530x325 | Standart Gastronom Küvetler GN 1/1 530x325



Ürün Kodu Product Code	Porsiyon Portion	Yükseklik (mm) Heigh (mm)	Kapasite (Lt.) Capacity (Lt.)	Fiyat Price
321.01.203	10	20	2,5	13 €
321.01.002	20	40	5	15 €
321.01.205	36	65	9	16 €
321.01.004	56	100	14	20 €
321.01.005	84	150	21	28 €
321.01.005	112	200	28	35 €

Standart Gastronom Küvetler GN 2/3 354x325 | Standart Gastronom Küvetler GN 2/3 354x325



Ürün Kodu Product Code	Porsiyon Portion	Yükseklik (mm) Heigh (mm)	Kapasite (Lt.) Capacity (Lt.)	Fiyat Price
321.01.203	5	20	-	10 €
321.01.002	8	40	-	12 €
321.01.205	18	65	-	14 €
321.01.004	24	100	-	16 €
321.01.005	36	150	-	24 €

Standart Gastronom Küvetler GN 1/2 325x265 | Standart Gastronom Küvetler GN 1/2 325x265



Ürün Kodu Product Code	Porsiyon Portion	Yükseklik (mm) Heigh (mm)	Kapasite (Lt.) Capacity (Lt.)	Fiyat Price
321.01.203	5	20	1,25	7 €
321.01.002	8	40	2	9 €
321.01.205	18	65	4,5	12 €
321.01.004	24	100	6	14 €
321.01.005	36	150	9	18 €

Mutfak Ekipmanları

Kitchen Equipments

Standart Gastronorm Küvet 1/3 325x176 | Standard Gastronorm Container 1/3 325x176

Ürün Kodu Product Code	Porsiyon Portion	Yükseklik (mm) Heigh (mm)	Kapasite (Lt.) Capacity (Lt.)	Fiyat Price
321.01.203	3	20	0,75	6 €
321.01.002	6	40	1,50	7 €
321.01.205	10	65	2,50	8 €
321.01.004	16	100	4	12 €
321.01.005	23	150	5,70	17 €
321.01.005	31	200	7,80	22 €



Standart Gastronorm Küvetler GN 1/4 265x162 | Standard Gastronorm Container GN 1/4 265x162

Ürün Kodu Product Code	Porsiyon Portion	Yükseklik (mm) Heigh (mm)	Kapasite (Lt.) Capacity (Lt.)	Fiyat Price
321.01.203	2	20	0,5	6 €
321.01.002	4	40	1	7 €
321.01.205	7	65	1,8	8 €
321.01.004	11	100	2,8	9 €
321.01.005	16	150	4	15 €
321.01.005	22	200	5,5	26 €



Standart Gastronorm Küvetler GN 1/6 176x162 | Standard Gastronorm Container GN 1/6 176x162

Ürün Kodu Product Code	Porsiyon Portion	Yükseklik (mm) Heigh (mm)	Kapasite (Lt.) Capacity (Lt.)	Fiyat Price
321.01.203	2	20	-	6 €
321.01.002	4	100	-	7 €
321.01.205	7	150	-	14 €



Standart Gastronorm Küvetler GN 1/9 176x108 | Standard Gastronorm Container GN 1/9 176x108

Ürün Kodu Product Code	Porsiyon Portion	Yükseklik (mm) Heigh (mm)	Kapasite (Lt.) Capacity (Lt.)	Fiyat Price
321.01.203	3	65	0,6	5 €
321.01.002	4	100	1	8 €



Standart Gastronom Kapak | Standard Gastronom Lid



Ürün Kodu Product Code	Model Model	Ebat (mm) Dimensions (mm)	Fiyat Price
321.01.203	GD 2/1	650x530	26 €
321.01.002	GD 1/1	530x325	13 €
321.01.205	GD 2/3	354x325	10 €
321.01.004	GD 1/2	325x265	8 €
321.01.005	GD 1/3	325x176	7 €
321.01.005	GD 1/4	65x162	5 €
321.01.203	GD 1/6	176x162	5 €
321.01.002	GD 1/9	176x108	4 €

Kepçe Delikli Gastronom Kapak | Perforated Gastronom Lid Bucket



Ürün Kodu Product Code	Model Model	Ebat (mm) Dimensions (mm)	Fiyat Price
321.01.203	GD 2/1	650x530	27 €
321.01.002	GD 1/1	530x325	15 €
321.01.205	GD 2/3	354x325	12 €
321.01.004	GD 1/2	325x265	9 €
321.01.005	GD 1/3	325x176	9 €
321.01.005	GD 1/4	265x162	8 €
321.01.203	GD 1/6	176x162	7 €

Sızdırmaz Gastronom Kapak | Gastronom Lid Sealing



Ürün Kodu Product Code	Model Model	Ebat (mm) Dimensions (mm)	Fiyat Price
321.01.203	GD 2/1	650x530	30 €
321.01.002	GD 1/1	530x325	29 €
321.01.205	GD 2/3	354x325	22 €
321.01.004	GD 1/2	325x265	19 €
321.01.005	GD 1/3	325x176	15 €
321.01.005	GD 1/4	265x162	14 €

Mutfak Ekipmanları

Kitchen Equipments

Evyeli Tablalar | Tables With Sink

Kod Code	Ürün Kodu Product Code	Tabla (mm) Table (mm)	Evyeye (mm) Sink (mm)	Ağırlık (Kg.) Weight (Kg.)	Fiyat Price
ET 101	62211100104040250	1000x600	400x400x250	9.25	161 €
ET 101	62211100104040250	1000x600	400x500x250	9.45	172 €
ET 101	62211120104040250	1200x600	400x400x250	10.47	182 €
ET 101	62211120104040250	1200x600	400x500x250	11.00	190 €
ET 101	62211140104040250	1400x600	400x500x250	12.15	210 €
ET 101	62211150104040250	1500x600	400x500x250	12.50	224 €
ET 101	62211160104040250	1600x600	400x500x250	13.00	238 €
ET 101	62211180104040250	1800x600	400x500x250	16.00	252 €
ET 101	62211200104040250	2000x600	400x500x250	17.25	266 €
M028	62211100104050250	1000x700	400x400x250	10.65	195 €
M028	62211100105050300	1000x700	400x500x300	10.85	200 €
M028	62211120104050250	1200x700	400x400x250	12.10	219 €
M028	62211120105050300	1400x700	400x500x300	-	224 €
M028	62211140105050300	1400x700	400x500x300	-	235 €
M028	62211150105050300	1500x700	400x500x300	-	250 €
M028	62211160105050300	1600x700	400x500x300	-	256 €
M028	62211180105050300	1800x700	400x500x300	-	284 €
M028	62211200105050300	2000x700	400x500x300	-	312 €



Çift Evyeli Tablalar | Double Sink Tables

Kod Code	Ürün Kodu Product Code	Tabla (mm) Table (mm)	Evyeye (mm) Sink (mm)	Ağırlık (Kg.) Weight (Kg.)	Fiyat Price
ET 102	62211140104040250	1400x600	400x500x250	-	267 €
ET 102	62211150104040250	1500x600	400x500x250	-	275 €
ET 102	62211160104040250	1600x600	400x500x250	-	280 €
ET 102	62211180104040250	1800x600	400x500x250	-	322 €
ET 102	62211200104040250	2000x600	400x500x250	-	340 €
ET 102	62211140105050300	1400x700	400x500x300	-	298 €
ET 102	62211150105050300	1500x700	400x500x300	-	303 €
ET 102	62211160105050300	1600x700	400x500x300	-	322 €
ET 102	62211180105050300	1800x700	400x500x300	-	373 €
ET 102	62211200105050300	2000x700	400x500x300	-	380 €



Evyeli Tablalar – Çift Damlalıklı | Tables With Double Sink



Kod Code	Ürün Kodu Product Code	Tabla (mm) Table (mm)	Evyeye (mm) Sink (mm)	Ağırlık (Kg.) Weight (Kg.)	Fiyat Price
ET 103	62211180104040250	1800x600	400x400x250	-	320 €
ET 103	62211190104050250	1900x600	400x500x250	-	354 €
ET 103	62211200104040250	1800x700	500x500x300	-	362 €
ET 103	62211180104050300	1900x700	500x500x300	-	368 €
ET 103	62211140104050300	2000x700	500x500x300	-	382 €

Üç Evyeli Tabla | Table with Three Sink



Kod Code	Ürün Kodu Product Code	Tabla (mm) Table (mm)	Evyeye (mm) Sink (mm)	Ağırlık (Kg.) Weight (Kg.)	Fiyat Price
ET 104	62211180104040250	1800x600	400x400x250	-	378 €
ET 104	62211180104050250	1800x600	400x500x250	-	388 €
ET 104	62211200104040250	1900x600	400x400x250	-	382 €
ET 104	62211180104050250	1900x600	400x500x300	-	399 €
ET 104	62211180104050300	1900x700	500x500x300	-	462 €

Yıkama Evyeleri | Washing Sink



Kod Code	Ürün Kodu Product Code	Ürün Adı Product Name	Evyeye (mm) Sink (mm)	Fiyat Price
ET 105	6215000000000000000	Yıkama Evyesi	413x505x130	266 €
ET 106	62321003012007000	Sebze Yıkama	1200x700x300	280 €
ET 107	6220354020000000000	Bar Tipi Evye	350x400x200	51 €
ET 109	6221160175000000000	Ayaktan Pedallı Evye	850x500x400	330 €

Steril Dolaplar | Steril Cabinets

Temel Özellikler

- 120 Dakika timer kontrollü
- UV filtrasyonlu renkli pleksi kapak
- Sac bıçaklı

Basic Features

- 120 minutes timer controlled
- Colored plexi cap with UV filtration
- Sheet metal blade

Ürün Kodu Product Code	Ebat (mm) Dimension (mm)	Fiyat Price
M08220	140x520x650	195 €
M08221	140x940x650	299 €

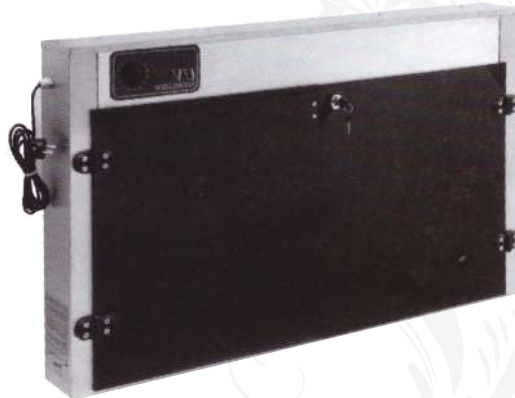

Mutfak Ekipmanları

Kitchen Equipments

Termobox – Üstten Yüklemeli | Termobox – Top Loading

Ürün Kodu Product Code	Model Model	Ebat (mm) Dimension (mm)	Fiyat Price
TBF100	Kapak Dahil	410x620x240	350 €
TBF300	Kapak Dahil	410x620x240	350 €
TBF400	Kapak Dahil	410x620x240	350 €
TBF1600	Kapak Dahil	410x620x240	350 €

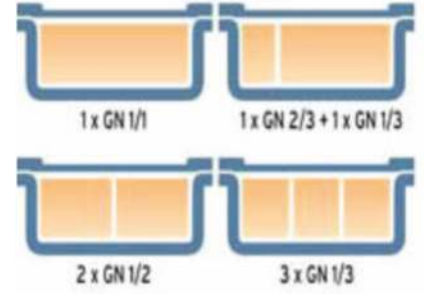

Temel Özellikler

- Ürünler EPP (genişletilmiş polipropilen) malzemeden imal edilmiştir.
- Sağlam, dayanıklı ve hafiftir.
- Mükemmel izolasyon özelliğine sahiptir. (-40°C/ +120°C)
- Hijyeniktir, bulaşık makinelerinde yıkanabilir.
- TFB100, TFB300, TFB400, TFB600

Basic Features

- Made of EPP (Expanded Polypropylene)
- Sturdy, durable and lightweight
- It has perfect isolation feature. (-40°C/ + 120°C)
- Hygienic and dishwasher-proof
- TFB100, TFB300, TFB400, TFB600



Termobox – Önden Yüklemeli | Front – Top Loading

Ürün Kodu Product Code	Model Model	Ebat (mm) Dimension (mm)	Fiyat Price
TBF600	Kapak Dahil	410x620x240	225 €

Temel Özellikler

- Ürünler EPP (genişletilmiş polipropilen) malzemeden imal edilmiştir.
- Sağlam, dayanıklı ve hafiftir.
- Mükemmel izolasyon özelliğine sahiptir. (-40°C/ +120°C)
- GN 1/1, GN 1/2, GN 1/3 Küvet için
- Hijyeniktir, bulaşık makinelerinde yıkanabilir.
- TFB600

Basic Features

- Made of EPP (Expanded Polypropylene)
- Sturdy, durable and lightweight
- It has perfect isolation feature. (-40°C/ + 120°C)
- For GN 1/1, GN 1/2, GN 1/3 containers
- Hygienic and dishwasher-proof
- TFB600

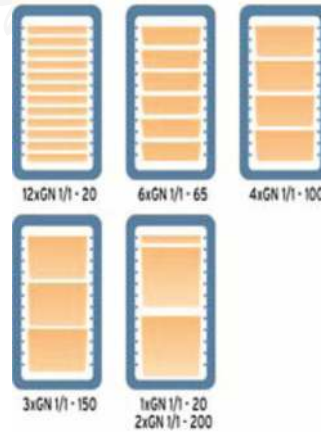

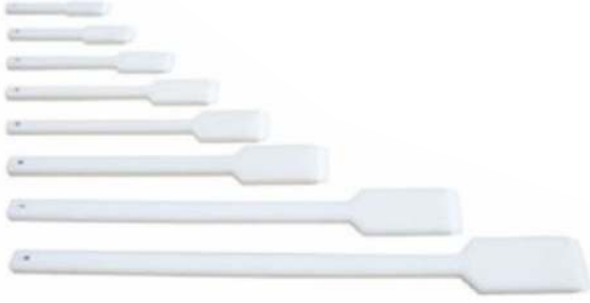

Pataşu | Patashu

Ürün Kodu Product Code	Ebat (mm) Dimention (mm)	Fiyat Price
0	300	24 €
0	350	16 €
0	450	17 €
0	550	18 €
0	650	23 €
0	750	29 €
0	1000	36 €
0	1200	76 €

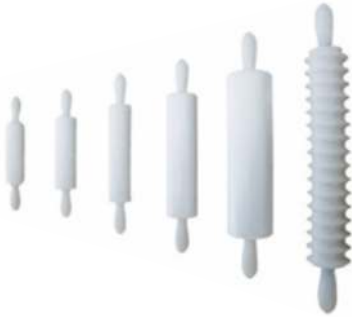

Merdane | Roller

Ürün Kodu Product Code	Model Model	Fiyat Price
0	Oval	55 €
0	Küçük	50 €
0	Dişli	60 €
0	Orta	55 €
0	Büyük	60 €
0	Mantı	82 €

Tulumba Tatlı Aparatı | Tulumba Dessert Util



Ürün Kodu Product Code	Ebat (mm) Dimention (mm)	Fiyat Price
0	65	29 €
0	80	37 €

Polietilen Kesim Levhaları | Polythene Cutting Tables

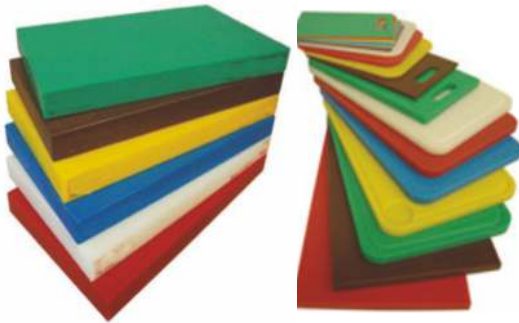

Ürün Kodu Product Code	Ebat (mm) Dimention (mm)	Fiyat Price
PST01	40x300x40	25 €
PST02	50x300x40	30 €
PST03	60x300x40	35 €
PST04	60x400x40	49 €
PST05	325x265x20	9 €
PST06	530x325x20	18 €
PST07	500x300x20	16 €
PST08	600x400x20	25 €

Paslanmaz Saplı Polietilen Kesim Levhaları | Polyethylene Cut Tables with Stainless Handle



Ürün Kodu Product Code	Ebat (Ø mm) Dimention (Ø mm)	Fiyat Price
0	300 x 2	19 €
0	400 x 2	25 €

Mutfak Ekipmanları

Kitchen Equipments

Sterilize Bıçak Kabı | Sterilized Knife Container

Model Model	Fiyat Price
Sterilize Bıçak Kabı	78 €



Polietilen Levha Temizleme Bıçağı | Polyethylene Tray Cleaning Knife

Model Model	Fiyat Price
Polietilen Levha Temizleme Bıçağı	6 €



Kıyma Makinesi Tokmağı | Mallets for Mince Meat Machine

Model Model	Et Koruyuculuğu Meat Preservation	Fiyat Price
Kıyma Makinesi Tokmağı	12	7 €
Kıyma Makinesi Tokmağı	22	10 €
Kıyma Makinesi Tokmağı	32	12 €
Kıyma Makinesi Tokmağı	42	19 €



Havan | Mortar

Model Model	Model Tipi Model Shape	Fiyat Price
Havan	Kare Square	21 €
Havan	Küçük Small	24 €
Havan	Orta Middle	26 €
Havan	Büyük Big	28 €



Diğer Ürünler | Other Products

**Bıçak Tutucu Miknatıslı** 10 €**Oklava 25cm** 21 € | **35cm** 22 €**Polietilen Levha Temizleme Fırçası** 6 €**Et Döveceği** 32 €**Çekmeceli Et Kesim Levhası** 88 €**İstif Rafı** 56 €**Polietilen Levha Temizleme Kimyasalı** 10 €



Location



PiMAK Factory:

Ziya Gökalp Mh. İkitelli Organize Sanayi Bölgesi 10. cad.
Atatürk Blv. No:112/4 Başakşehir / İstanbul / Türkiye
E-Mail: info@pimak.com • www.pimak.com.tr



Location



DAMPAK Factory:

Rami Kışla cd. Topçular mh. Tikvesli sk. 1. Tikveşli Çıkmazı
No:4 Eyüp / İstanbul / Türkiye
E-Mail: info@dampak.com.tr • www.dampak.com.tr



Location



BOĞAZİCİ Factory:

Karadeniz Mahallesi, Cebeci Caddesi, No:171/A Küçükköy,
Gaziosmanpaşa / İstanbul / Türkiye
E-Mail:bogazici@bogazicimakina.com • www.bogazicimakina.com



Location



MİR Factory:

Hamidiye Mah. Eyyubi Cad. Minyatür Sok. No.29 PK. 34925
Sultanbeyli/ İstanbul / Türkiye
E-Mail: info@mir-tr.com • www.mir-tr.com

Blank lined area for notes.



Blank lined area for notes.



Blank lined area for notes.



Blank lined area for notes.



PIMAK
GROUP

www.pimak.com

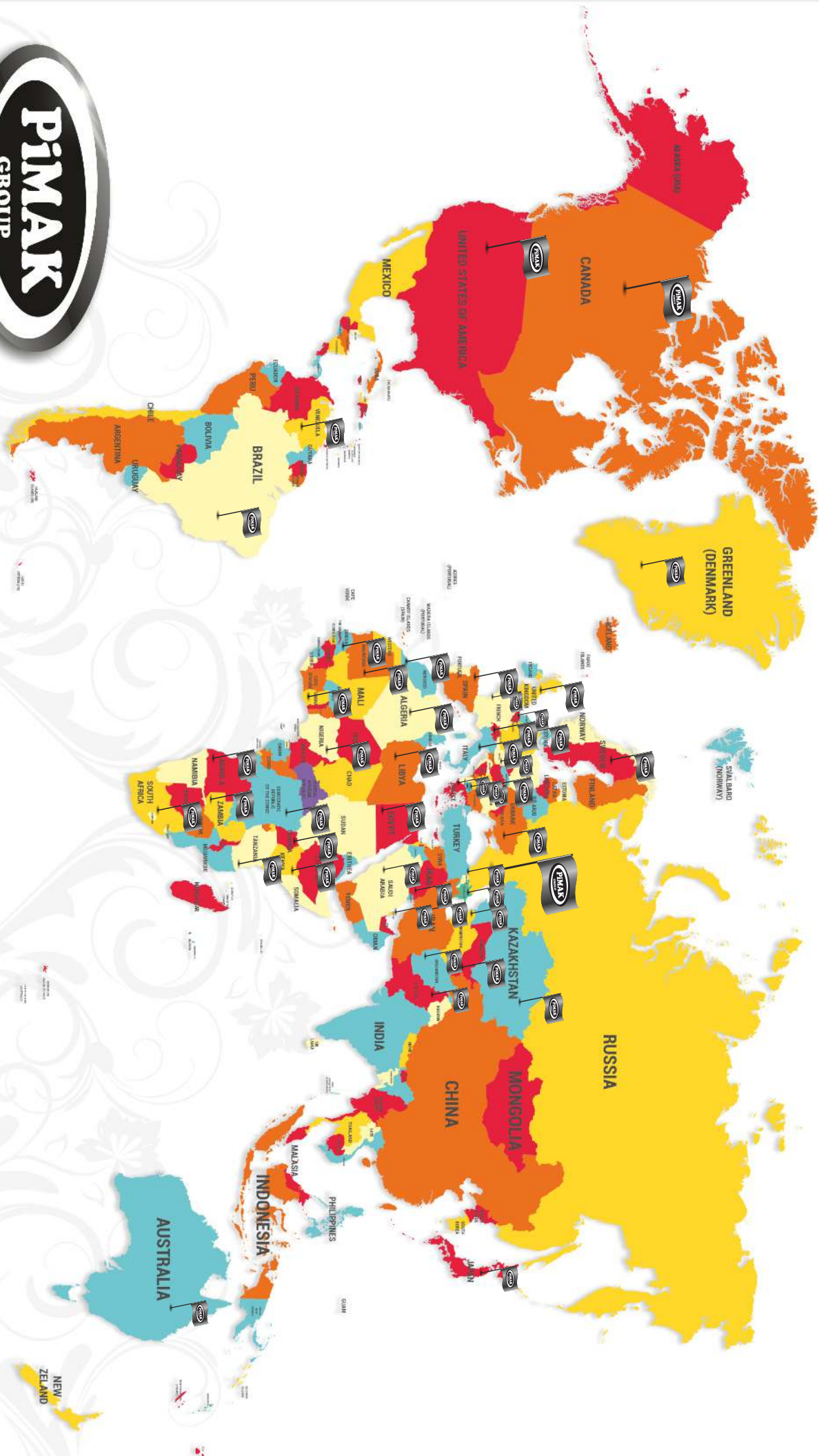

more than 65 countries...

